

REV.	ECN NO OR DESCRIPTION	REVISED	DATE
A	PDR NO: S131105-8A	Dengfeng	2014.05.30
B	ECN NO: S151227-E	Ken	2016.1.22

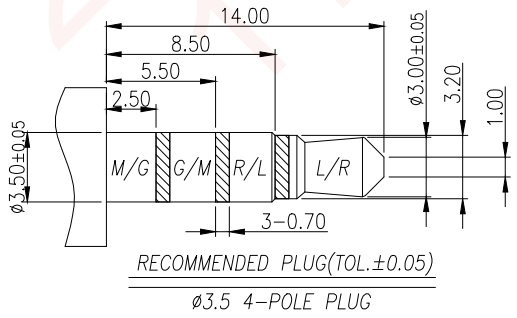
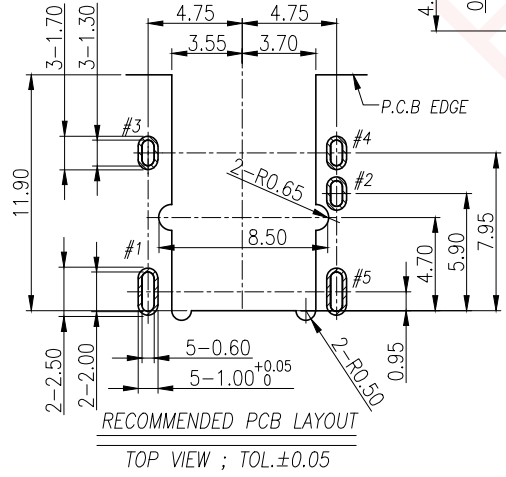
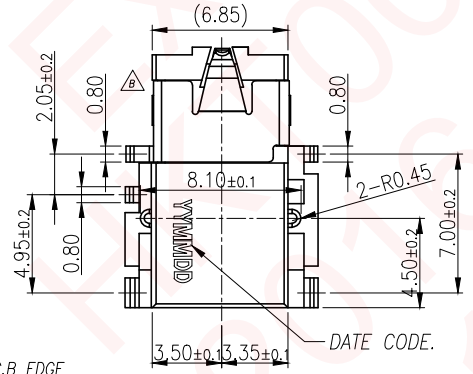
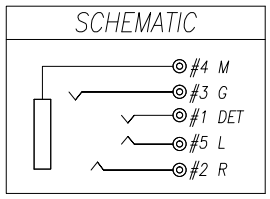
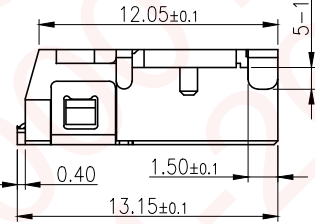
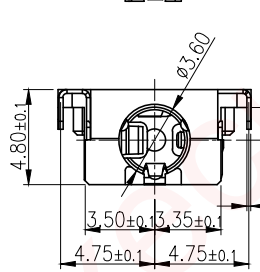
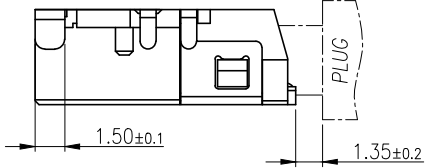
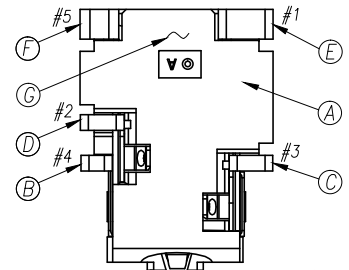

- SPECIFICATIONS:
- INSULATION RESISTANCE BETWEEN ANY ADJACENT OPEN CIRCUIT TERMINAL SHELL NOT BE LESS THAN 100MΩ MEASURED BY 500 VDC.
 - CONTACT RESISTANCE: 50mΩ MAX(INITIAL).
 - INSULATION VOLTAGE WITHSTAND:500V AC FOR ONE MINUTE.
 - UNLESS OTHERWISE SPECIFIED. TEST IS TO BE MADE AT 5-35°C IN TEMPERATURE AND 45-85% IN HUMIDITY. BUT,IF ANY VAGUE DATA IS OCCURED ON TEST RESULT, ANOTHER TEST SHALL BE MADE AT 20°C±2°C IN TEMP., 60-70% IN HUMIDITY.
 - LIFE TEST: 5,000 CYCLES MIN.
 - INSERTION FORCE: 0.3 - 3.0Kg.
 - WITHDRAWAL FORCE: 0.3 - 3.0Kg.
 - AFTER LIFE TEST, CONTACT RESISTANCE: 100mΩ MAX.
 - AFTER HUMIDITY TEST, INSULATION RESISTANCE: 50MΩ MIN.
 - MARKING: MARK "S" ON TOP OF CONNECTOR.
 - PACKING : TAPE & REEL.
 - TO CONFORM TO SINGATRON HAZARDOUS SUBSTANCE FREE SPEC.
 - HALOGEN FREE PRODUCT IDENTIFICATION MARK ON PRODUCT:
 - HALOGEN FREE PRODUCT IDENTIFICATION LOGO ON PACKAGING:

G	DUMMY	1	SUS304-1/2H 0.25t	Ni 50u"
F	L	1	SUS304-1/2H 0.25t	Au 4u" ON CONTACT AREA; GOLD FLASH ON SOLDER AREA; ALL OVER 50u" NI.
E	DET	1	PHOSPHOR BRONZE 0.2t	
D	RING	1	PHOSPHOR BRONZE 0.2t	
C	GROUND	1	PHOSPHOR BRONZE 0.2t	
B	MIC	1	PHOSPHOR BRONZE 0.2t	
A	BODY	1	HIGH TEMP.THERMOPLASTIC	BLACK
NO	DESCRIPTION	QTY	MATERIAL	PLATING & COLOR

UNLESS OTHERWISE SPECIFIED TOLERANCES		Singatron Enterprise Co., Ltd. 信音企業股份有限公司	
DECIMALS:	ANGLES:	TITLE: 3.5ø PHONE JACK	
X :±0.1	X :±2°	DWN	Ken PART NO. 2SJ3113-008111F
X.X :±0.1	X.X :±1°	CHKD	cerry SCALE 4:1 UNIT: mm
X.XX :±0.1		APVD	Lussen SIZE: A3 SHEET:1 OF 1 REV:B
CUSTOMER COPY			