

RoHS Compliant

Notes:

- 1.Current Rating: 12V&1A max.
- 2.Contact Resistance: 50mOhms Max.(intial)
- 3.Insulation Resistance: 100M Ohms Min./500V DC
- 4.Dielectric Withstanding Voltage: 500V AC/1Minute
- 5.Mating Force: 50N Max, Withdrawal Force: 8N Min.
- 6.Durability: 5,000 Cycles
- 7.Operating Temperature:-25°C to+85°C

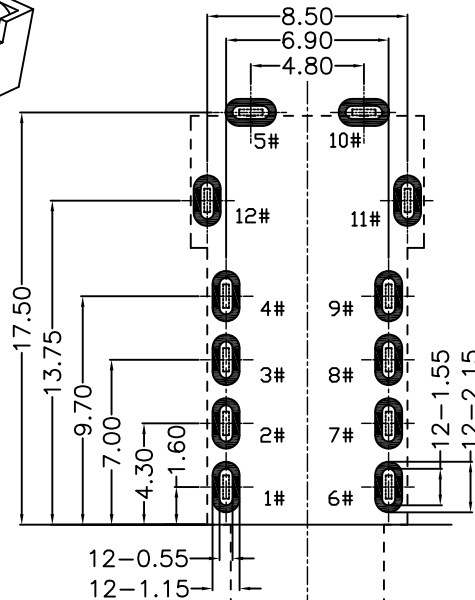
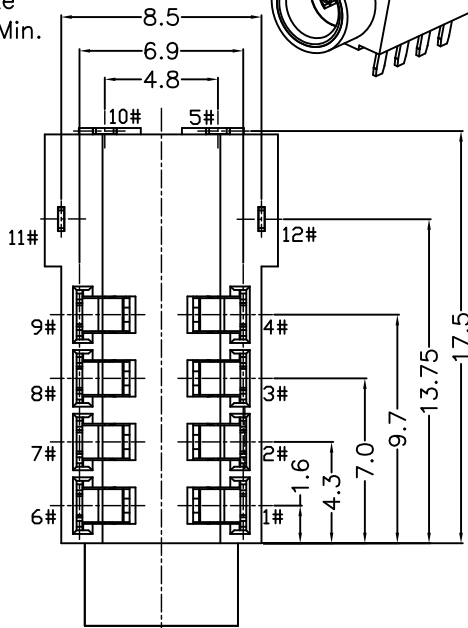
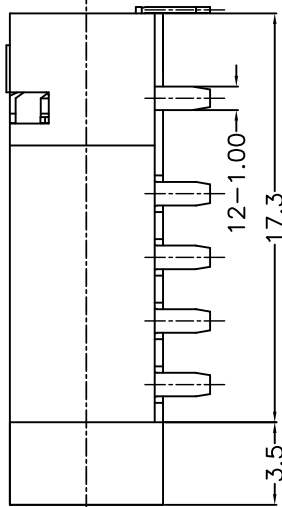
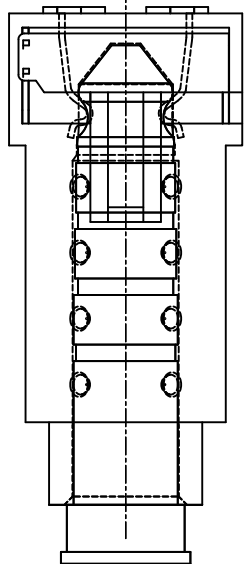
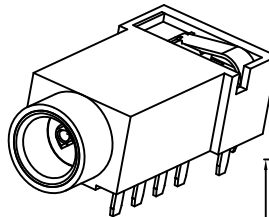

RECOMMEND PCB LAYOUT
TOLERANCE:±0.05

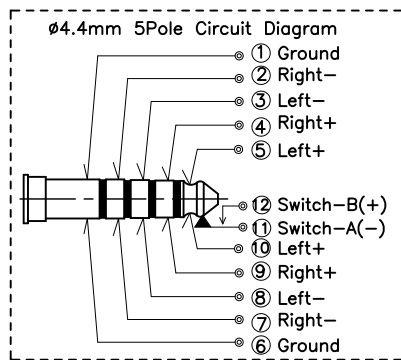
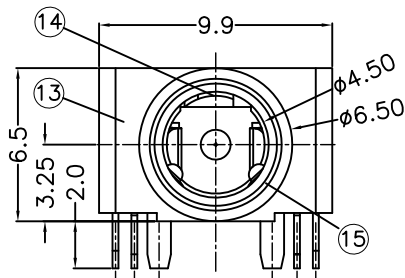

15	Sleeve	Copper Alloy	G/F Plated Overall.
14	Separator		
13	Housing	Thermoplastics	Black UL 94-V0
12	Switch-A(+)		
11	Switch-B(-)		
5/10	Left+ Contact	Copper Alloy	G/F On Contact Area & Solder Tails Ni Plated Overall.
4/9	Right+ Contact		
3/8	Left- Contact		
2/7	Right- Contact		
1/6	GND Contact		
Item	Name	Material	Description

UNLESS OTHERWISE SPECIFIED TOLERANCES

DECIMALS:		ANGLES:	
DIM	TOL	DIM	TOL
X.	±0.50	X.	±2°
X.X	±0.30	X.X	±1°
X.XX	±0.20	X.XX	///
X.XXX	±0.10	X.XXX	///

Singatron Enterprise Co., Ltd.

TITLE	Φ4.4 5POLE AUDIO JACK		
DWN	Tony	PART NO.	2SJ4412-0973000H
CHKD	2021.11.23	SCALE 1:1	UNIT: mm
APVD	Andy	SIZE: A3	SHEET:1 OF 1 REV: A1

CUSTOMER COPY

REV.	ECN NO.	DESCRIPTION	DESIGN	DATE
------	---------	-------------	--------	------