

SPECIFICATION:
 Current Rating:0.5A
 Voltage Rating:5.0V AC/DC
 Contact Resistance:100mΩ MAX.
 Insulation Resistance:500MΩ Min.
 Dielectric Withstanding Voltage:250V AC
 Durability:3000 cycles
 Peak Temperature:260°C±5°C
 Operating Temperature:-40°C~+85°C
 Package: tape reel, 1500pcs/Reel

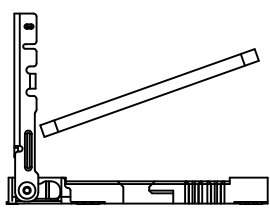

STEP 1 INSERT NANO SIM CARD

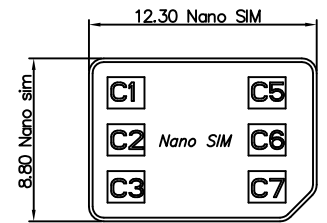
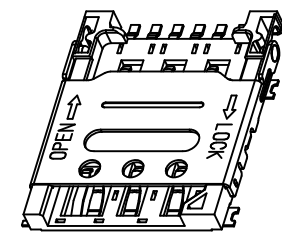
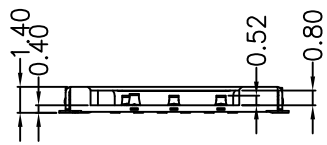
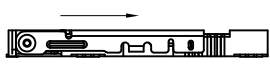

STEP 2 PUSH THE SHELL

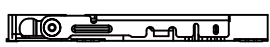

STEP 3 FINISH

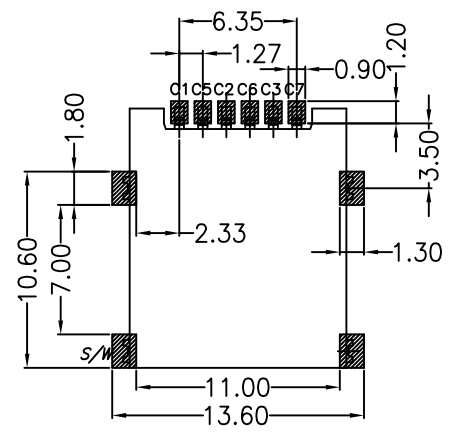

RECOMMENDED PCB LAYOUT
 GENERAL TOLERANCE ±0.05

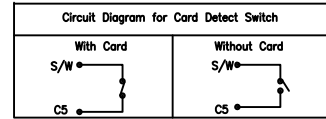

PIN NO.	PIN NAME
C1	VCC
C2	RST
C3	CLK
C5	GND
C6	VPP
C7	I/O
S/W	Detect PIN

Singatron Enterprise Co., Ltd.

GENERAL TOLERANCE		TITLE	Nano-SIM Conn. Flip Type H:1.40 With Detect pin			
XX. ±	XXX. ±	DWN	COCO	PART NO. 2SM6402-ST034001D0-S		
X. ± 0.30	.XXX ± 0.05	CHKD	2015/04/11	SCALE 1:1	UNIT: mm	
.X ± 0.25	X.* ± 3'	APVD	JAMES	SIZE: A3	SHEET: 1 OF 2	REV: 3
.XX ± 0.20	.X.* ± 2'	CUSTOMER COPY				

1 2 3 4 5 6 7 8

F

F

E

E

D

D

C

C

B

B

A

A

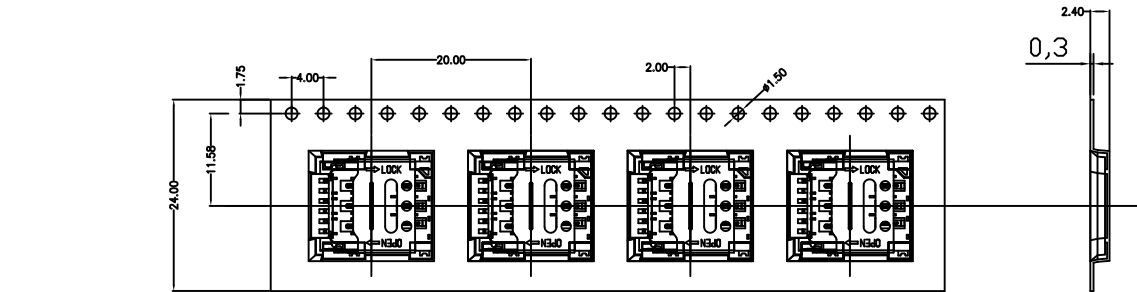

NOTES:

- 1, tape reel package, 1500PCS/reel;
- 2, K=K carton, 15Kpcs/carton;
- 3, Cover peeling force; 30~130gf

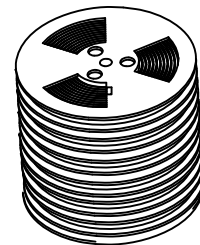
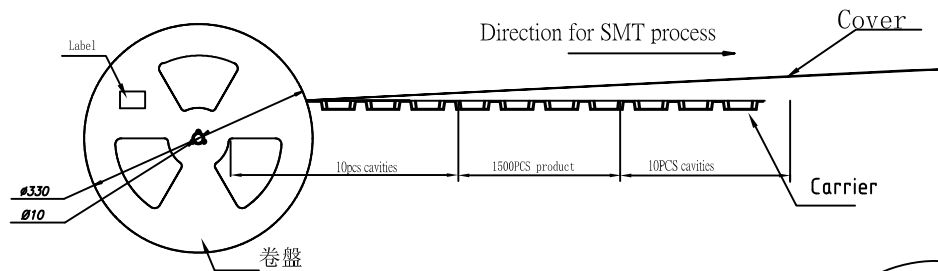

1500pcsX10=15000pcs

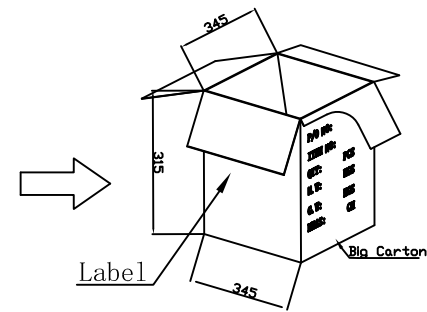

Singatron Enterprise Co., Ltd.

GENERAL TOLERANCE		TITLE	Nano-SIM Conn. Flip Type H:1.40 With Detect pin			
XX. ±	XXX. ±	DWN	COCO	PART NO.2SM6402-ST034001D0-S		
X. ± 0.30	.XXX ± 0.05	CHKD	2015/04/11	SCALE 1:1	UNIT: mm	⊕ ↻
.X ± 0.25	X.* ± 3'	APVD	JAMES	SIZE: A3	SHEET:2 OF 2	REV: 3
.XX ± 0.20	.X.* ± 2'	CUSTOMER COPY				

1 2 3 4 5 6 7 8