

REV.	ECN NO. OR DESCRIPTION	REVISED	DATE
A	PDR NO.: T130724-2A	Susie	2013.10.15

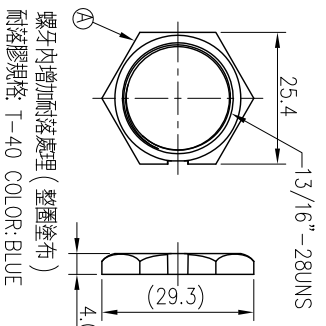

SPRING WASHER

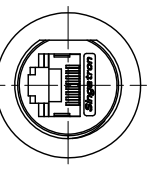
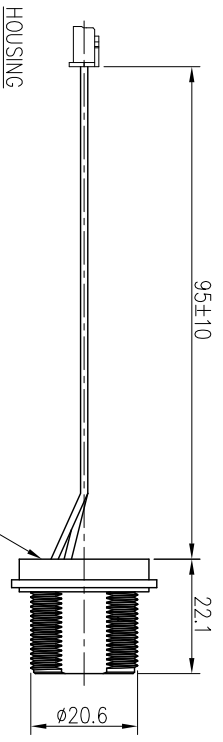
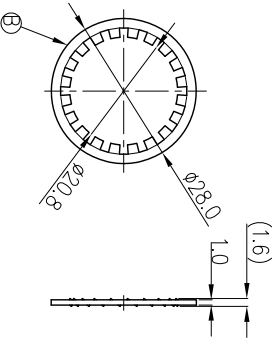

WATERPROOF RATE: IP67

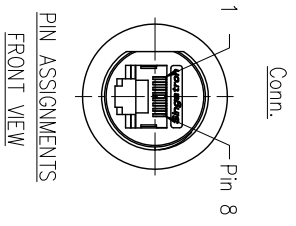
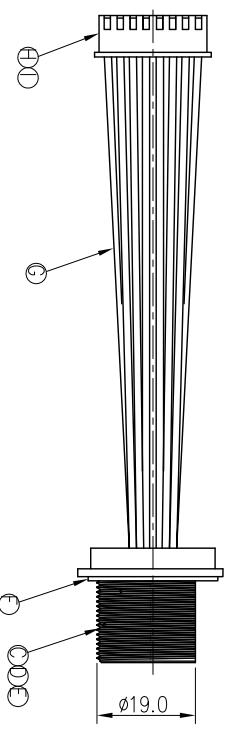

PIN ASSIGNMENTS
 FRONT VIEW

- NOTES:
1. WATERPROOF RATE: IP67
 IP67: IMMERSED IN 1M WATER FOR 30 MINUTES
 2. ELECTRICAL CHARACTERISTICS:
 - 2-1. RATING: 125V 1.5A
 - 2-2. CONTACT RESISTANCE: 30 MAX. (INITIAL)
 - 2-3. DIELECTRIC WITHSTANDING VOLTAGE: 300V AC FOR ONE MINUTE
 - 2-4. INSULATION RESISTANCE: 30MΩ MIN. MEASURED BY 500 VDC
 3. OTHER GENERAL SPEC. TO REFER "RJ45 SERIES SPEC".
 4. TO CONFORM TO SINGATRON HAZARDOUS SUBSTANCE FREE SPEC.
 5. GREEN PRODUCT IDENTIFICATION LABEL ON PACKAGING: **G.P. PASS**
 6. FOR PANEL THICKNESS MAX OF 4.3mm

HOUSING

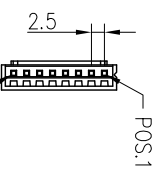
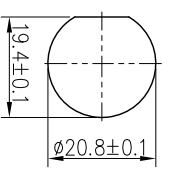

1	GRAY	8
2	BLACK	7
3	GRAY	6
5	BLACK	5
6	GRAY	4
4	BLACK	3
7	GRAY	2
8	BLACK	1
HOUSING	WIRE COLOR	CONN.

J	GLUE	1	SILICON	BLACK
I	TERMINAL	8	P/N: TU3001TP0-A	TIN-PLATED
H	HOUSING	1	P/N: TU3001HND-08	WHITE
G	WIRE	8	UL1007 24AWG	BLACK/GRAY
F	GASKET	1	EPDM	BLACK
E	CAT.5e	1	N/A	30U" GOLD PLATED
D	SCREW	1	STAINLESS STEEL	N/A
C	BODY	1	ZINC ALLOY	120U" NICKEL PLATED
B	SPRING WASHER	1	SUS304	N/A
A	PANEL NUT	1	ZINC ALLOY	120U" NICKEL PLATED
NO	DESCRIPTION	QTY	MATERIAL	PLATING & COLOR

UNLESS OTHERWISE SPECIFIED TOLERANCES

Singatron Enterprise Co., Ltd.
 信營企業股份有限公司

TITLE: RJ45 KEYSTONE JACK SOCKET

DWN: Susie PART NO. 27J3003-W05129H

CHKD: JF SCALE 1:1 UNIT: mm

APVD: Quon SIZE: A3 SHEET: 1 OF 1 REV: A

CUSTOMER COPY