

REV.	ECN NO. OR DESCRIPTION	REVISED	DATE
A	PDR NO.:T120130-3A	LILY	2013.06.04

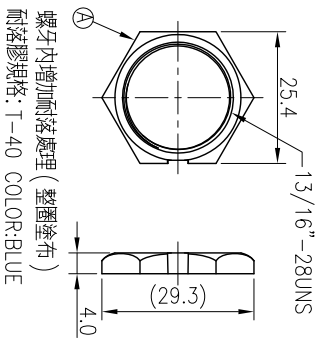

SPRING WASHER  
(1.6)

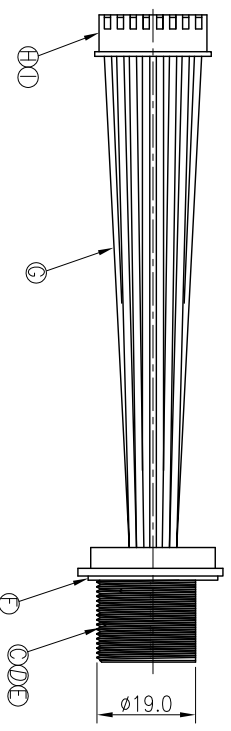
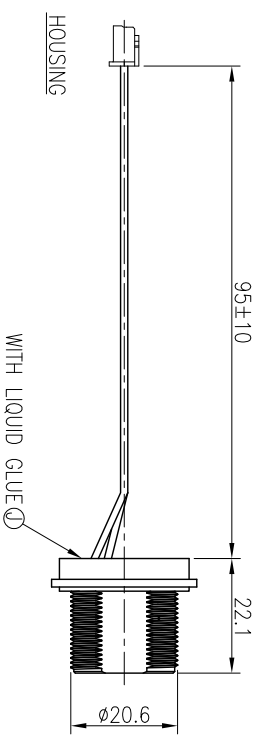
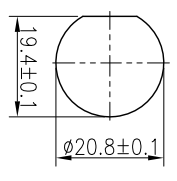
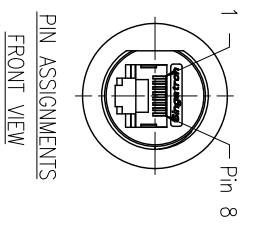
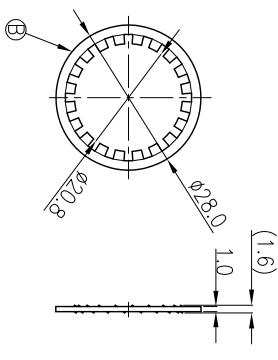

WATERPROOF RATE: IP67

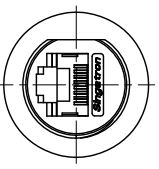

- NOTES:
1. WATERPROOF RATE: IP67
  2. RATING: 125V 1.5A
  3. OTHER GENERAL SPEC. TO REFER "RJ45 SERIES SPEC."
  4. TO CONFORM TO SINGATRON HAZARDOUS SUBSTANCE FREE SPEC.
  5. GREEN PRODUCT IDENTIFICATION LABEL ON PACKAGING: **G.P. PASS**
  6. FOR PANEL THICKNESS MAX OF 4.3mm

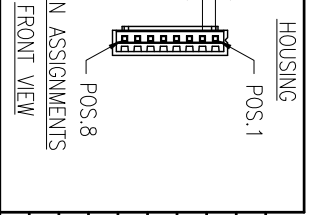

1	RED	8
2	BLACK	7
3	RED	6
4	BLACK	5
5	RED	4
6	BLACK	3
7	RED	2
8	BLACK	1

HOUSING WIRE COLOR CONN.

J	SILICONE	1	940-4	BLACK
I	TERMINAL	8	P/N:TU3001TP0-A	TIN-PLATED
H	HOUSING	1	P/N:TU3001HNO-08	WHITE
G	WIRE	8	UL1007 24AWG	BLACK/RED
F	GASKET	1	EPDM	BLACK
E	CAT.5e	1	N/A	30u" GOLD PLATED
D	SCREW	1	STAINLESS STEEL	N/A
C	BODY	1	ZINC ALLOY	120u" NICKEL PLATED
B	SPRING WASHER	1	SUS304	N/A
A	PANEL NUT	1	ZINC ALLOY	120u" NICKEL PLATED
NO	DESCRIPTION	QTY	MATERIAL	PLATING & COLOR

UNLESS OTHERWISE SPECIFIED TOLERANCES

Singatron Enterprise Co., Ltd.  
信營企業股份有限公司

DECIMALS: ANGLES: TITLE R445 KEYSTONE JACK SOCKET

DWN LILY PART NO. 2TJ3003-W05130P

CHKD James SCALE 1:1 UNIT: mm

APVD Harlen SIZE: A3 SHEET: 1 OF 1 REV: A

CUSTOMER COPY