

REV.	ECN NO. OR DESCRIPTION	REVISED	DATE
A	PDR NO.: T130724-2B	Susie	2013.10.15

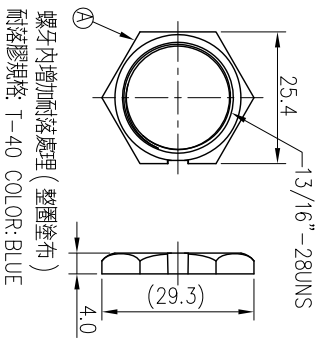

SPRING WASHER

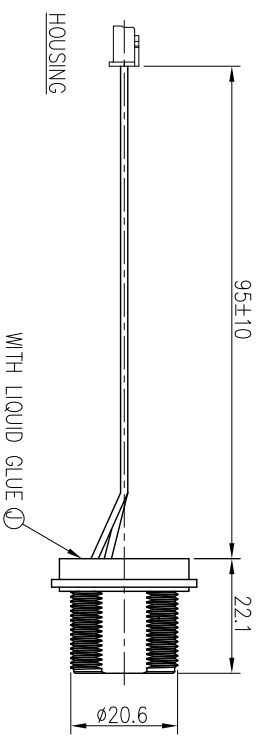
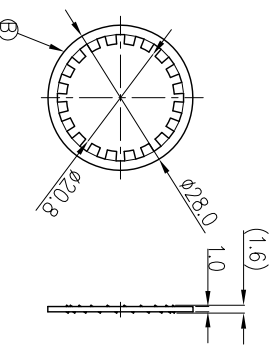

WATERPROOF RATE: IP67

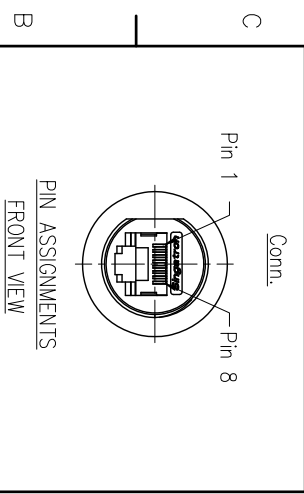
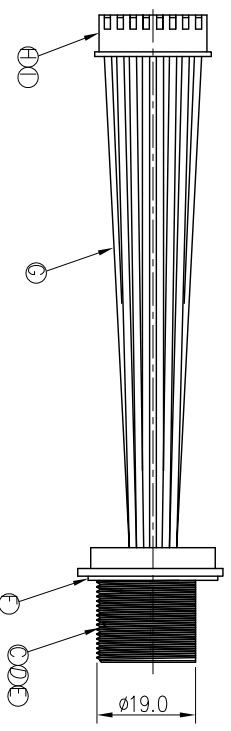
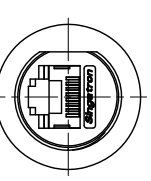

- NOTES:
1. WATERPROOF RATE: IP67
 2. RATING: 125V 1.5A
 3. OTHER GENERAL SPEC. TO REFER "RJ45 SERIES SPEC".
 4. TO CONFORM TO SINGATRON HAZARDOUS SUBSTANCE FREE SPEC.
 5. GREEN PRODUCT IDENTIFICATION LABEL ON PACKAGING: **G.P. PASS**
 6. FOR PANEL THICKNESS MAX OF 4.3mm

HOUSING

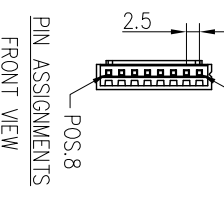
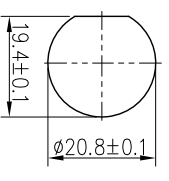

1	RED	8
2	BLACK	7
3	RED	6
4	BLACK	5
5	RED	4
6	BLACK	3
7	RED	2
8	BLACK	1

HOUSING WIRE COLOR CONN.

J	GLUE	1	SILICON	BLACK
I	TERMINAL	8	P/N: TU3001TP0-A	TIN-PLATED
H	HOUSING	1	P/N: TU3001HNO-08	WHITE
G	WIRE	8	UL1007 24AWG	BLACK/RED
F	GASKET	1	EPDM	BLACK
E	CAT.5e	1	N/A	30U" GOLD PLATED
D	SCREW	1	STAINLESS STEEL	N/A
C	BODY	1	ZINC ALLOY	120U" NICKEL PLATED
B	SPRING WASHER	1	SUS304	N/A
A	PANEL NUT	1	ZINC ALLOY	120U" NICKEL PLATED
NO	DESCRIPTION	QTY	MATERIAL	PLATING & COLOR

UNLESS OTHERWISE SPECIFIED TOLERANCES

Singatron Enterprise Co., Ltd.
信晉企業股份有限公司

RJ45 KEYSTONE JACK SOCKET

TITLE: RJ45 KEYSTONE JACK SOCKET

DWN: Susie PART NO. 2TJ3003-W051301

CHKD: Jf SCALE 1:1 UNIT: mm

APVD: Quon SIZE: A3 SHEET: 1 OF 1 REV: A

CUSTOMER COPY