

REV.	ECN NO.	OR DESCRIPTION	REVISED	DATE
A	PDR NO.:	S:51026-9A	Blues	2016.6.12

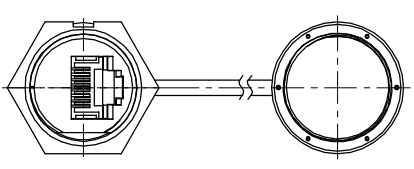

CONN.1  
WATERPROOF RATE: IP67

8	BROWN	8
7	BLUE	7
6	YELLOW	6
5	GREEN	5
4	RED	4
3	BLACK	3
2	ORANGE	2
1	GREY	1
PCB	WIRE COLOR	CONN2

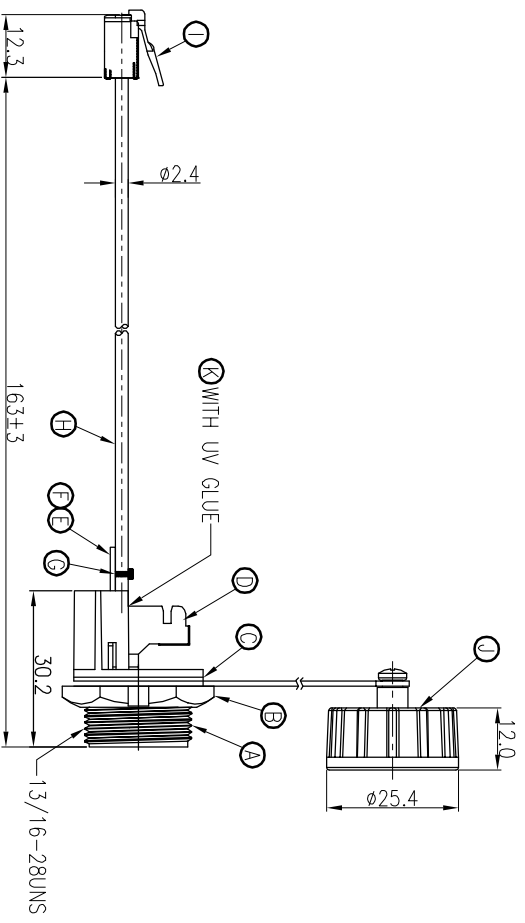
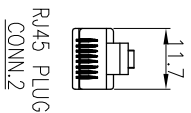
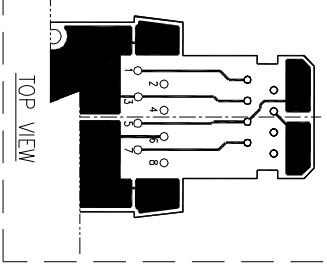
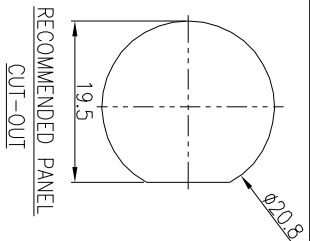
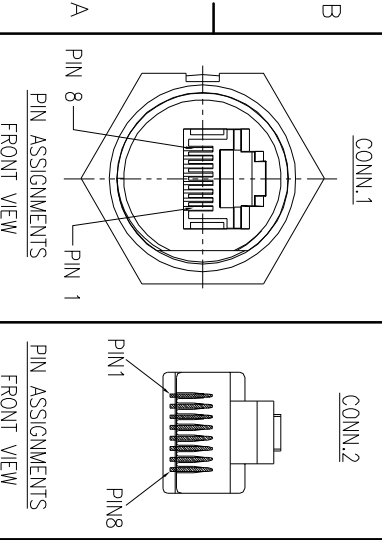
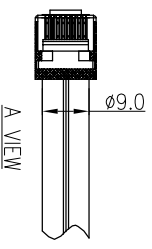

- NOTES:
1. WATERPROOF RATE: IP67(WHEN PROPERLY MATED)  
IP67: IMMERSED IN 1M WATER FOR 30 MINUTES
  2. RATING:125V 1.5A
  3. OTHER GENERAL SPEC. TO REFER "RJ45 SERIES SPEC";
  4. TO CONFORM TO SINGATRON HAZARDOUS SUBSTANCE FREE SPEC.
  5. GREEN PRODUCT IDENTIFICATION LABEL ON PACKAGING: **RoHS**
  6. FOR PANEL THICKNESS MAX OF 3.5mm

K	UV GLUE	1	N/A	WHITE
J	WATERPROOF CAP	1	P/N:2UB3001-W0000W	BLACK
I	RJ45 PLUG	1	CAT6 8P8C SHORT SHIELD	GOLD PLATING
H	CABEL	1	N0UL 26AWG*8C FLAT	GRAY(PVC JACKET)
G	CABLE TIES	1	UV RESISTANT OD2.4*9.0	BLACK
F	CRJ45	1	N/A	GOLD PLATING
E	PCB	1	FR-4	GREEN
D	GROUND	1	PHOSPHOR BRONZE	NICKEL PLATING
C	GASKET	1	EPDM	BLACK
B	NIUT	1	NYLON+GF	BLACK
A	HOUSING	1	PPE	BLACK
NO	DESCRIPTION	QTY	MATERIAL	PLATING & COLOR

UNLESS OTHERWISE SPECIFIED TOLERANCES

Singatron Enterprise Co., Ltd.  
信登企業股份有限公司

DECIMALS:	ANGLES:
X :±0.5	X :±2°
X.X :±0.3	X.X :±1°
X.XX :±0.2	

TITLE	RJ45 SHIELDED JACK + PLUG
DWN	Blues
CHKD	Horlen
APVD	Steve
PART NO.	27J3003-W05187H
SCALE	1:1
UNIT	mm
SIZE	A3
SHEET	1 OF 1
REV	A

CUSTOMER COPY