

REV.	ECN NO OR DESCRIPTION	REVISED	DATE
A	PDR NO.:T180312-3A	Vicky	2018.02.28
B	ECN NO.: S202006-P02	JAY	2020.11.25
C	ECN NO.: S202102-E03	JAY	2021.02.22

PANEL NUT

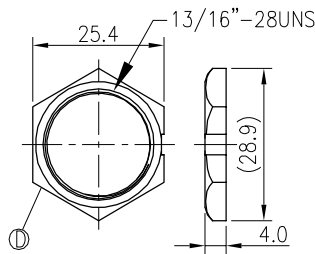

螺牙內增加耐落處理 (整圈塗布)
耐落膠規格: T-40 COLOR: BLUE

GASKET

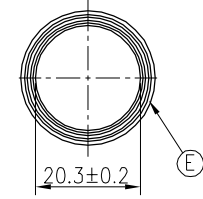

WATERPROOF CAP

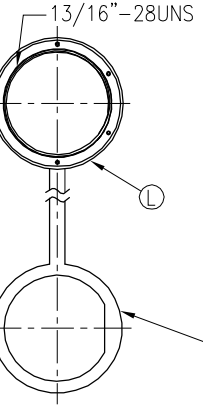

RJ45 PLUG: E136825 PC CAT5E RJ45 FTP PLUG V-0

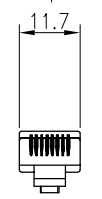

CONN.2
RJ45 PLUG

CABLE: E188601 CAT.5E 4P*24AWG+M+D+AL 80°C 30V CMG

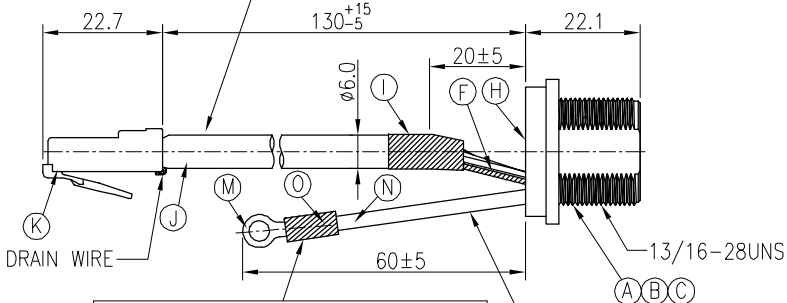

TUBE: E203950 ϕ 3.5 125°C 600V VW-1

WIRE: E315421 UL1015-18AWG 105°C 600V VW-1

PCB: E330731 FR-4 V-0

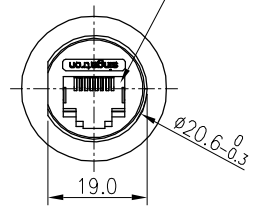

CONN.1
WATERPROOF RATE: IP67

WATERPROOF CAP: E82268 PPE 540Z V-0

SHELL	DRAIN	SHELL	YELLOW&GREEN
8	ORANGE/WHITE	8	TWIST
7	ORANGE	7	
6	GREEN/WHITE	6	
5	BLUE	5	
4	BLUE/WHITE	4	
3	GREEN	3	
2	BROWN/WHITE	2	
1	BROWN	1	
CONN.2	WIRE COLOR	CONN.1	TWIST
PIN OUT			

- NOTES:
- WATERPROOF RATE: IP67
IP67: IMMERSED IN 1M WATER FOR 30 MINUTES
 - RATING: 125V 1.5A
 - TEMPERATURE RANGE: -20°C TO +80°C
 - OTHER GENERAL SPEC. TO REFER "RJ45 SERIES SPEC".
 - TO CONFORM TO SINGATRON HAZARDOUS SUBSTANCE FREE SPEC.
 - GREEN PRODUCT IDENTIFICATION LABEL ON PACKAGING: **G.P. PASS**
 - FOR PANEL THICKNESS MAX OF 4.3mm

O	TUBE	1	Δ ϕ 3.5 125°C 300V L=15	BLACK
N	WIRE	1	UL1015-18AWG	YELLOW&GREEN
M	O-TERMINAL	1	ID3.7 ϕ 7.0	TIN PLATED
L	WATERPROOF CAP	1	P/N:2UB3001-W0000W	BLACK
K	RJ45 PLUG	1	8P8C SHIELD	GOLD PLATING
J	CABEL	1	CAT5E FTP 24#*4P+MY+D+A/M (UV RESISTANT)	BLACK(PVC JACKET)
I	TUBE	1	ϕ 7.0 125°C 300V L=15	BLACK
H	LIQUID GLUE	1	N/A	BLACK
G	SPRING WASHER	1	STAINLESS STEEL	N/A
F	TUBE	1	ϕ 1.0 125°C 300V L=20	BLACK
E	GASKET	1	SILICONE	BLACK
D	PANEL NUT	1	BRASS C3604 Δ	NICKEL PLATED
C	SCREW	1	SUS 304	N/A
B	RJ45+PCB	1	N/A	N/A
A	HOUSING	1	ZINC ALLOY	NICKEL PLATED
NO	DESCRIPTION	QTY	MATERIAL	PLATING & COLOR

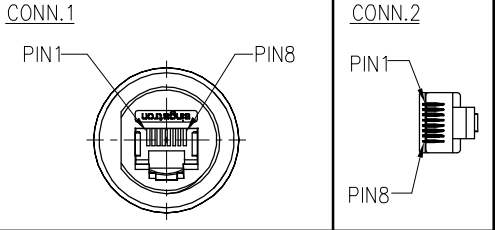

PIN ASSIGNMENTS
FRONT VIEW

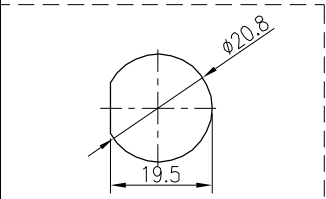

RECOMMENDED PANEL CUT-OUT

UNLESS OTHERWISE SPECIFIED TOLERANCES

Singatron Enterprise Co., Ltd.
信音企業股份有限公司

DECIMALS:	ANGLES:	TITLE	RJ45 SHIELDED JACK + PLUG		
X : ±0.5	X : ±2°	DWN	JAY	PART NO.2TJ3003-W051D1H	
X.X : ±0.3	X.X : ±1'	CHKD	JF	SCALE 1:1	UNIT: mm
X.XX : ±0.2		APVD	William	SIZE: A3	SHEET: 1 OF 1
					REV: C

CUSTOMER COPY