

REV	ECN No.	DATE	REMARK
A1	---	2016.06.29	新增料号
A2	---	2016.11.26	图面升级

NOTES:

SPECIFICATION:

- CURRENT RATING: 3A MAX
- VOLTAGE: 100 VAC
- TEMPERATURE RANGE: -30 °C ~ 85 °C
- CONTACT RESISTANCE: 40 MILLIONHM MAX
- INSULATION RESISTANCE: 100 MEGOHMS MIN.
- INSERTION FORCE : 5N~20N
- UNMATING FORCE: 8N~20N
- DURABILITY: 10,000 CYCLES

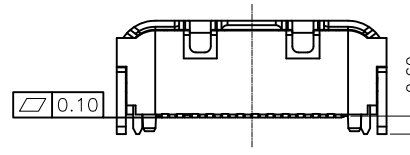
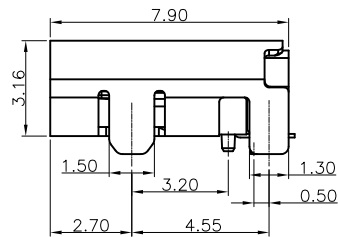
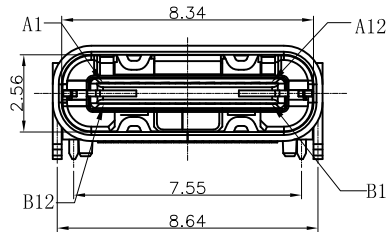
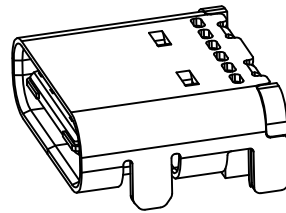
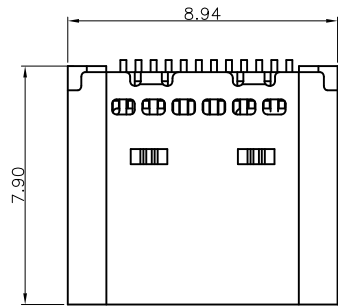

料号对照表

料号	镀金规格	胶芯颜色
2UB-014101010-025	有柱无凸包端子焊脚Matte tin	黑色
2UB-014101010-031	有柱无凸包端子焊脚Au:3"	黑色
2UB-014101020-082	有柱无凸包端子焊脚Au:5"	黑色
2UB-014101050-075	有柱无凸包端子焊脚Au:15"	黑色
2UB-014101050-049	有柱无凸包端子焊脚Au:30"	黑色
2UB-014101020-084	有柱无凸包端子焊脚Au:3"	橙色

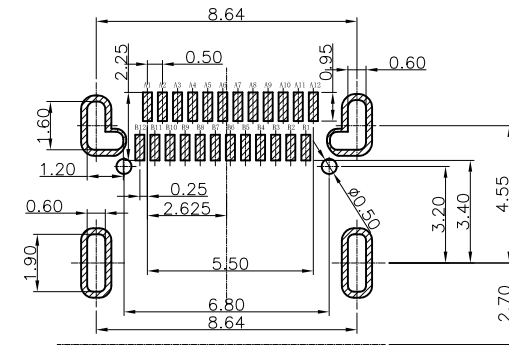

RECOMMENDED P.C.B. LAYOUT  
TOLERANCE UNSPECIFIED ±0.05mm

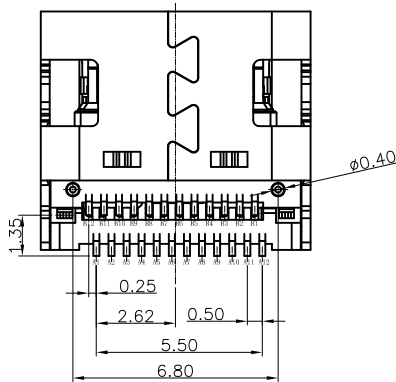

A1	GND	B12	GND
A2	SSTXP1	B11	SSRXP1
A3	SSTXN1	B10	SSRXN1
A4	VBUS	B9	VBUS
A5	CC1	B8	SBU2
A6	DP1	B7	DN2
A7	DN1	B6	DP2
A8	SBU1	B5	CC2
A9	VBUS	B4	VBUS
A10	SSRXN2	B3	SSTXN2
A11	SSRXP2	B2	SSTXP2
A12	GND	B1	GND
PIN	SIGNAL NAME	PIN	SIGNAL NAME

NO.	DESCRIPTION	MATERIAL	REMARKS	QTY
8	铁壳	SUS 304-1/2H,T=0.30	NI Plated	1PCS
7	弹片	SUS 301-1/2H,T=0.10	---	1PCS
6	铁片	SUS 301-3/4H,T=0.20	---	1PCS
5	铁片半成品	LCP UL94V-0	---	1PCS
4	后端子	CI814-H,T=0.12	Sn/Au3u"/Au5u"/Au15u"/NI Plated	1SET
3	前端子	CI814-H,T=0.12	Sn/Au3u"/Au5u"/Au15u"/NI Plated	1SET
2	后插半成品	LCP UL94V-0	BLACK	1PCS
1	前插半成品	LCP UL94V-0	BLACK	1PCS

QUALITY SYMBOL	GENERAL TOLERANCES (UNLESS SPECIFIED)	
	x.xxxxx	± ---
	x.xxx	± ---
	x.xx	± 0.25
	x.x	± 0.30
ANGULAR	± 3°	

Singatron Enterprise Co., Ltd.

TITLE	USB C F TYPE 双排SMT 四脚插板 有柱无凸包CONN		
DWN	DMX 2016.06.29	PART NO. 2UB-014101050-xxx	
CHKD	DMX 2016.06.29	SCALE 1:1	UNIT: mm
APVD	DMX 2016.06.29	SIZE: A3	SHEET:1 OF 1

CUSTOMER COPY