

REV	ECN No.	DATE	REMARK
A0	NEW	2016.05.14	新版发行
A1	ECN1707005	2017.07.05	变更新料号

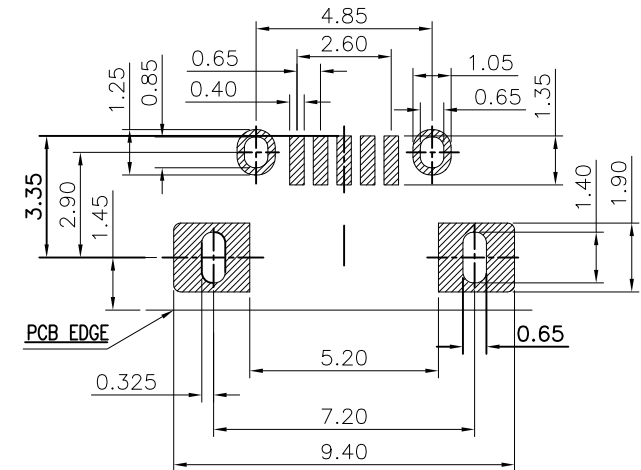

SPECIFICATION:

- CURRENT RATING: 0.5A(2.3.4CONTACT)/1.8A(1.5CONTACT) MAX.
- VOLTAGE: 30 VAC
- TEMPERATURE RANGE: -30 °C ~ 85 °C
- CONTACT RESISTANCE: 30 MILLIONHM MAX.
- DIELECTRIC WITHSTANDING VOLTAGE: 250 VAC r.m.s
- INSULATION RESISTNACE: 100 MEGOHMS MIN

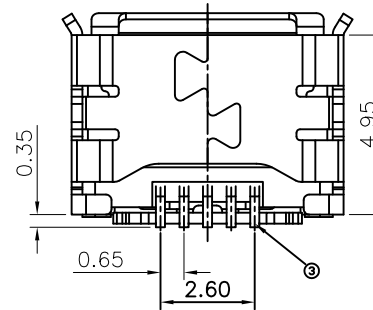
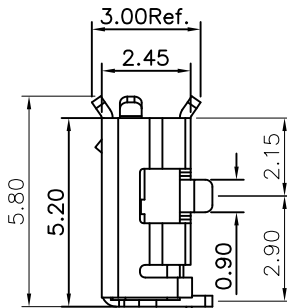
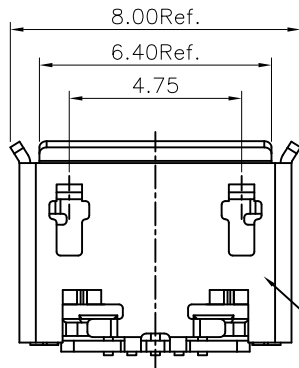
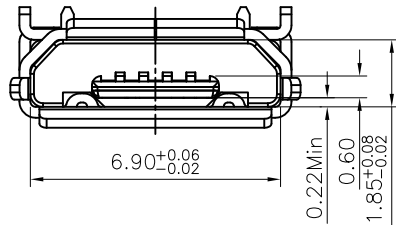
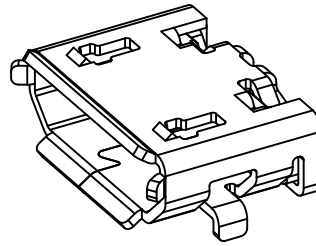

RECOMMENDED P.C.B. LAYOUT  
TOLERANCE UNSPECIFIED ±0.05mm  
(TOP VIEW)

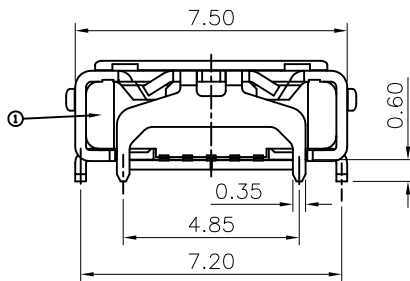

TABLE:

1	2UB-MF001TLB11R-A-01	2	SHELL	1	STAINLESS STEEL T=0.30mm ,Tin PLATED	N/A
		3	CONTACT	5	COPPER ALLOY-0.15MM G/F PLATING, Ni UNDERPLATING OVERALL	
2	2UB-MF001SL115R-A-01	3	CONTACT	5	COPPER ALLOY-0.15MM Au 30µ PLATING ON CONTACT AREA, Other Au/Ni PLATING, Ni UNDERPLATING OVERALL	N/A
		2	SHELL	1	STAINLESS STEEL T=0.30mm ,Ni 50u Min PLATED	
		1	HOUSING	1	LCP 94V-0 COLOR:BLACK	
No.	PART NUMBER	ITEM	PART NAME	Q'TY	Material	客户料号

GENERAL TOLERANCES  
(UNLESS SPECIFIED)

x.xxxx	± ---
x.xxx	± 0.10
x.xx	± 0.20
x.x	± 0.30
ANGULAR	± ---°

Singatron Enterprise Co., Ltd.

TITLE	MICRO USB 5P 全插式有翻边		
DWN	Sam 2017.07.05	PART NO.2UB-MF001XXXXX-X-01	
CHKD	Jay 2017.07.05	SCALE 1:1	UNIT: mm
APVD	Jacke 2017.07.05	SIZE: A3	SHEET:1 OF 1 REV: A1

CUSTOMER COPY