

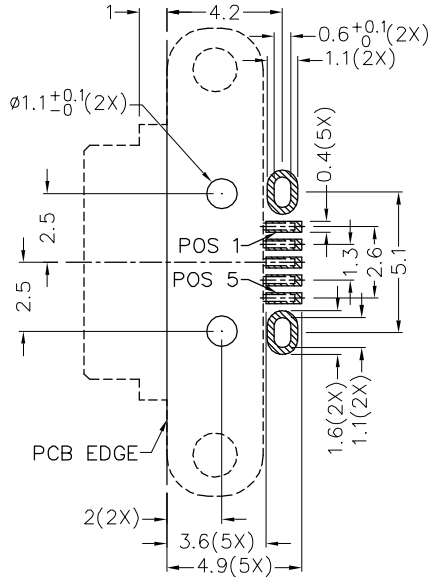

RoHS
Compliant

ZONE	SYMBOL	REVISION	APPROVAL	DATE
		ADD DUSTPROOF LOGO	J.X.KUANG	6-11-201

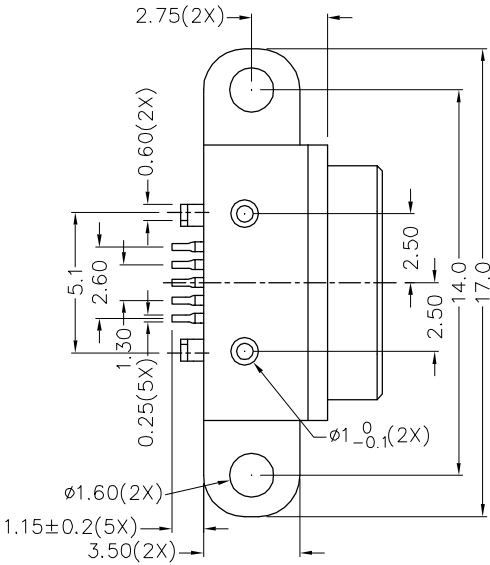
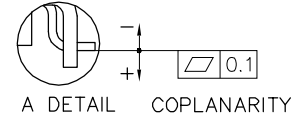
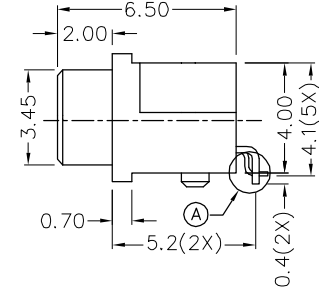
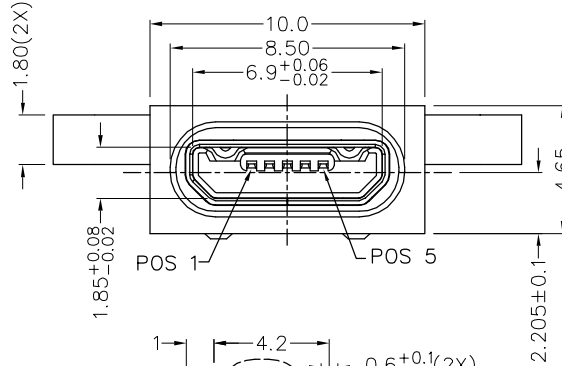
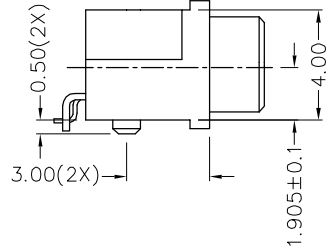
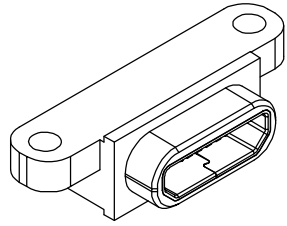

RECOMMENDED PCB LAYOUT
TOLERANCE: ±0.05
(TOP VIEW)

DESCRIPTION	MATERIAL	PLATING
TERMINALS	COPPER ALLOY	NICKEL PLATED ON ALL AREA, GOLD FLASH ON CONTACT & SOLDER AREA
SHELL	STAINLESS STEEL	NICKEL PLATED
HOUSING	HIGH TEMP. PLASTIC	
INSULATOR	HIGH TEMP. PLASTIC	

Singatron Enterprise Co., Ltd.

TITLE	WATERPROOF/DUSTPROOF MICRO USB B TYPE CONNECTOR		
DWN	H.L.TAN 6-11-2017	PART NO.	2UB-TW4002D
CHKD	J.H.ZHOU 6-11-2017	SCALE	1:1 UNIT: mm
APVD	T.Y.HU 6-11-2017	SIZE	A3 SHEET: 1 OF 1 REV: A

TOLERANCE UNLESS 0.0±0.2
OTHERWISE SPECIFIED: 0.00±0.1
0.000±0.05

CUSTOMER COPY

1

2

3

4

5

6

7

8

F

E

D

C

B

A

F

E

D

C

B

A

RoHS
Compliant

ZONE	SYMBOL	REVISION	APPROVAL	DATE
		VERSION FORMAT CHANGED FROM ALPHABET TO NUMERIC	J.X.KUANG	17-3-2017

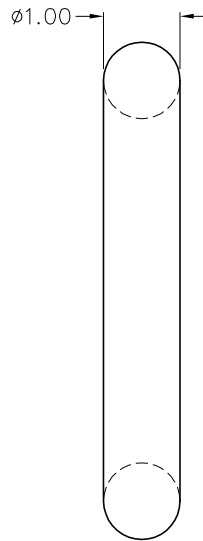
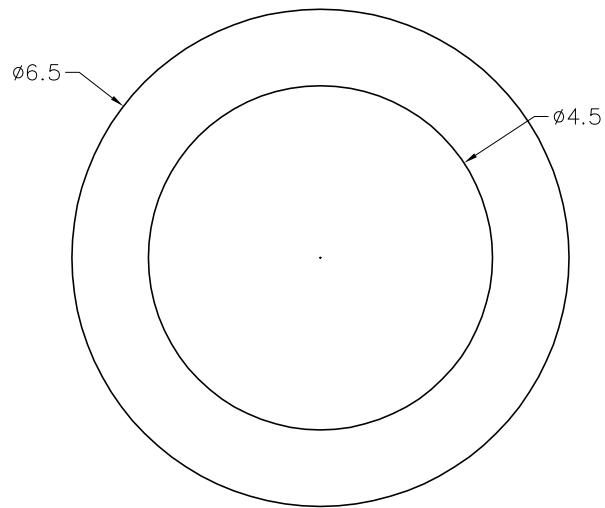

NOTES
 MATERIAL
 M1.MATERIAL: Silicone,94V-0
 M2.HARDNESS: 70°

Singatron Enterprise Co., Ltd.

TITLE	O-RING			
DWN	H.L.TAN 17-3-2017	PART NO.	O-RING-1	
CHKD	J.H.ZHOU 17-3-2017	SCALE	1:1	UNIT: mm
APVD	T.Y.LI 17-3-2017	SIZE: A3	SHEET: 1 OF 1	REV: A

TOLERANCE UNLESS 0.0±0.2
 0.00±0.1
 OTHERWISE SPECIFIED: 0.000±0.05

CUSTOMER COPY