

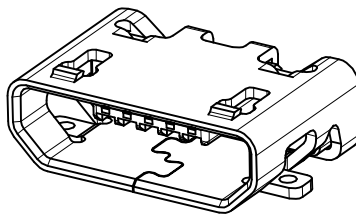

REV.	ECN NO OR DESCRIPTION	REVISED	DATE
A	PDR RELEASE	IVY-C	2015.12.21

PICK&PLACE AREA D/C(年/周/星期)

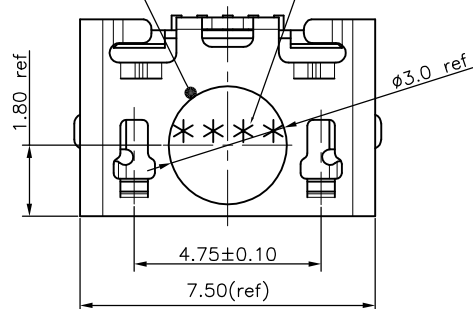

SPECIFICATIONS:

- ELECTRICAL CHARACTERISTICS:
 - CONTACT RESISTANCE: 30mΩ MAX.
 - DIELECTRIC WITHSTANDING VOLTAGE: 100V AC FOR 1 MINUTE
 - INSULATION RESISTANCE: 1000MΩ MIN
- MECHANICAL CHARACTERISTICS:
 - INSERTION FORCE : 3.5 Kgf Max.
 - WITHDRAWAL FORCE : 0.8 Kgf Min.
- DURABILITY: 10,000 CYCLES.
- TO CONFORM TO THE SINGATRON HAZARDOUS SUBSTANCE FREE SPEC.
- HALOGEN FREE PRODUCT IDENTIFICATION LABEL ON PACKAGING: 
- PACKAGE: SEE "2UB1677-000111F" PACKAGE.
- FOR REFLOW SOLDERING LEAD-FREE PROCESS.
- OTHER GENERAL SPEC. TO REFER "2UB1677-000111F SPEC".

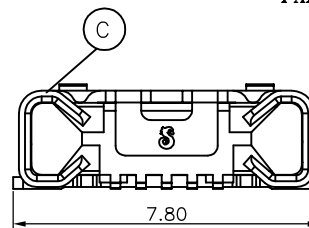
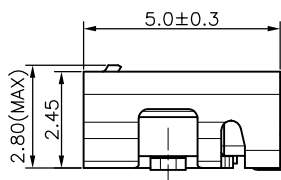
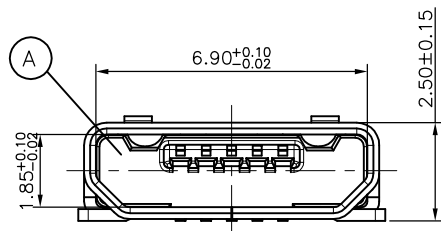

PART NO.
2UB1677-000111F

SUFFIX: HALOGEN FREE

PACKAGE
1: TAPE & REEL



HOUSING COLOR
1: BLACK

CONTACT PLATING

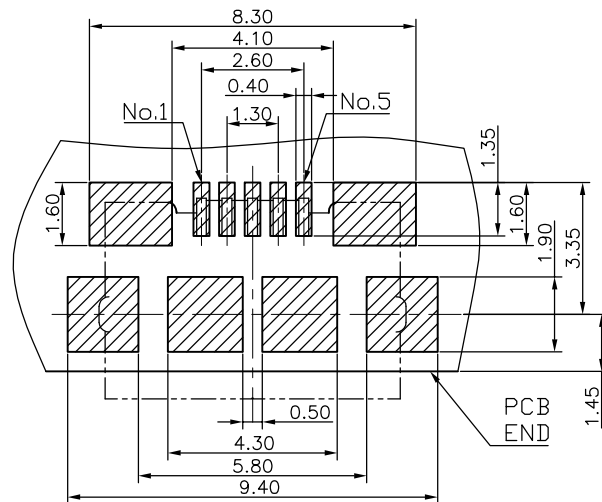
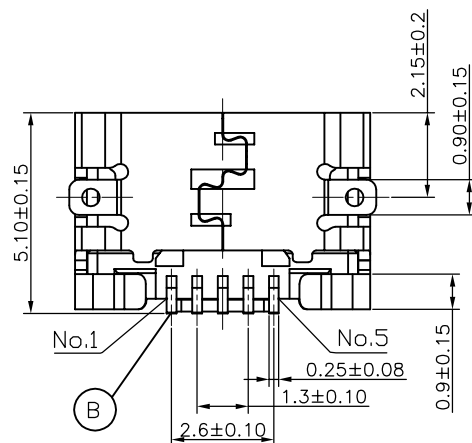
1: CONTACT :
AU 30u" PLATED ON MATING AREA,
GOLD FLASH ON SOLDERING AREA,
30u" MIN. NICKEL UNDER PLATING OVERALL



PCB LAYOUT
*General tolerance is ±0.05mm.

C	SHELL	1	SUS 304	MATTE TIN
B	TERMINAL	5	BRASS	SEE PART NO.
A	HOUSING	1	LCP UL 94V-0	BLACK
NO	DESCRIPTION	QTY	MATERIAL	PLATING & COLOR
UNLESS OTHERWISE SPECIFIED TOLERANCES		 Singatron Enterprise Co., Ltd.  信音企業股份有限公司		
DECIMALS:	ANGLES:	TITLE	MICRO USB 5P B TYPE CONNECTOR	
X : ±0.5	X : ±2°	DWN	IVY-C 2015.12.21	PART NO. 2UB1677-000111F
X.X : ±0.3	X.X : ±1°	CHKD	ANGELA2015.12.21	SCALE 1:1 UNIT: mm
X.XX : ±0.2		APVD	ANGELA2015.12.21	SIZE: A3 SHEET: 1 OF 1 REV: A
CUSTOMER COPY				