

REV.	ECN NO OR DESCRIPTION	REVISED	DATE
A	PDR RELEASE	EVEN	2022.09.23

SPECIFICATIONS:

- ELECTRICAL CHARACTERISTICS:
  - CURRENT RATING: 1.8A
  - VOLTAGE RATING: 30V
  - CONTACT RESISTANCE: 30mΩ MAX.
  - INSULATION RESISTANCE: 100MΩ MIN AT DC 250V.
- MECHANICAL CHARACTERISTICS:
  - INSERTION FORCE: 35N MAX.
  - WITHDRAWAL FORCE: 10N~35N
- LIFE TEST: 5,000 CYCLES.
- TEMPERATURE RANGE: -55°C TO +85°C.
- TO CONFORM TO THE SINGATRON HAZARDOUS SUBSTANCE FREE SPEC.
- HALOGEN FREE PRODUCT IDENTIFICATION LABEL ON PACKAGING: 
- PACKAGE: SEE "2UB1787-101111F" PACKAGE.
- FOR REFLOW SOLDERING LEAD-FREE PROCESS.
- SALT SPRAY TEST 48H PASS.
- OTHER GENERAL SPEC. TO REFER "2UB1787-101111 SPEC".

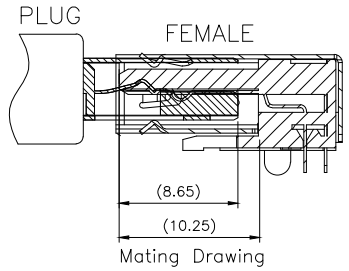
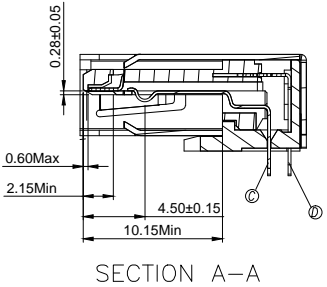
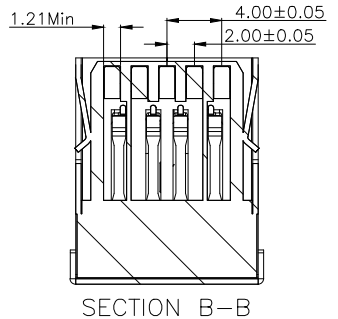
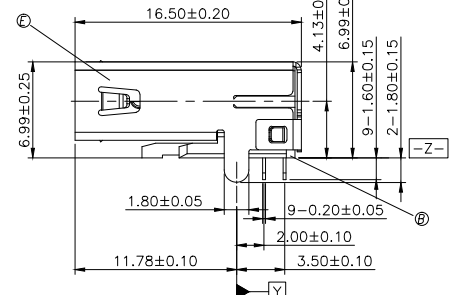
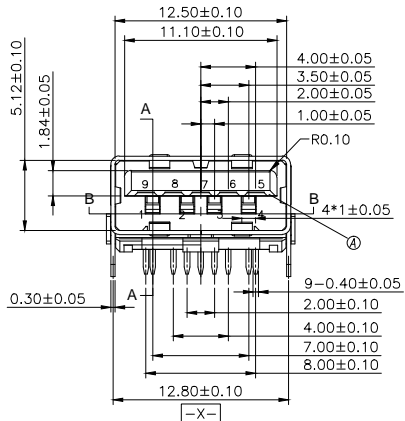
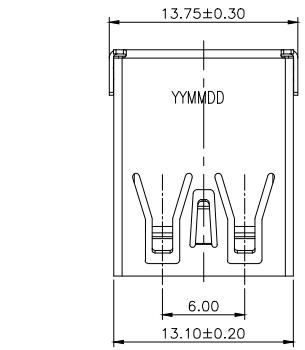
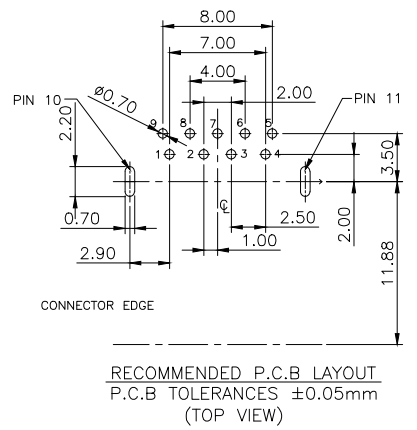

PART NO.  
2UB1787-101111F

FOR USB 3.2 SPECIFICATION  
1: Gen 2(10G)

- SUFFIX: HALOGEN FREE
- PACKAGE  
1: TAPE&REEL
- HOUSING  
1: BLUE(300C)
- CONTACT PLATING  
1: GOLD FLASH(1u" MIN.) PLATING ON CONTACT AREA,  
MATTE Sn 100u" MIN. ON SOLDERING AREA,  
50u" MIN. NICKEL UNDER PLATING OVERALL

E	SHELL	1	SUS201	80u" MIN. NICKEL
D	5PIN TERMINAL	5	C2680	SEE PART NO.
C	4PIN TERMINAL	4	C5191	SEE PART NO.
B	COVER	1	PA9T UL 94V-0	BLUE(300C)
A	HOUSING	1	PA9T UL 94V-0	BLUE(300C)
NO	DESCRIPTION	QTY	MATERIAL	PLATING & COLOR

UNLESS OTHERWISE SPECIFIED TOLERANCES

DECIMALS:	ANGLES:	TITLE	USB 3.2 TYPE,R/A ,DIP TYPE	
X : ±0.5	X : ±2°	DWN	EVEN 2022.09.23	PART NO. 2UB1787-101111F
X.X : ±0.3	X.X : ±1°	CHKD		SCALE N/A UNIT: mm
X.XX : ±0.2		APVD	ANGELA 2022.09.23	SIZE: A3 SHEET: 1 OF 1 REV:A

 信音科技(香港)有限公司

CUSTOMER COPY