

REV.	ECN NO.	OR DESCRIPTION	REVISED	DATE
A	PRODUCT RELEASE	Ares	2011.12.01	
B	ECN:C120179	ADD MYLAR	DAOWEN	2012.06.05

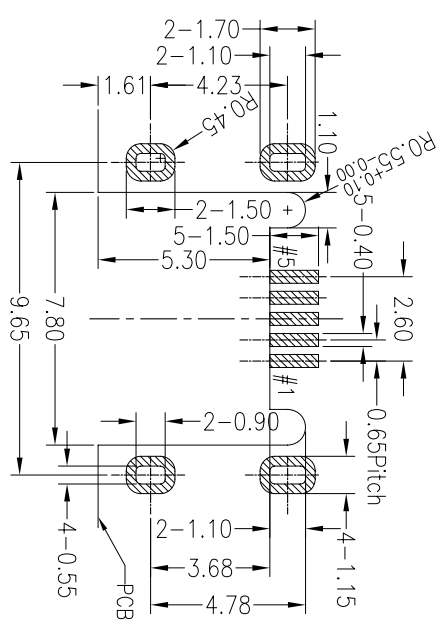

RECOMMENDED PCB LAYOUT  
TOP VIEW, TOL ±0.05

- SPECIFICATIONS:
- ELECTRICAL CHARACTERISTICS:
    - RATING: 2A (PIN1/5), 0.5A (PIN2/3/4)
    - CONTACT RESISTANCE: 30mΩ MAX.(INITIAL) 40mΩ MAX.(FINAL)
    - ELECTRIC WITHSTANDING VOLTAGE: 500V AC FOR ONE MINUTE.
    - INSULATION RESISTANCE: 100MΩ MIN. MEASURED BY 500 VDC
  - MECHANICAL CHARACTERISTICS:
    - INSERTION FORCE : 3.6 KGF (MAX)
    - WITHDRAWAL FORCE : 0.8 KGF(Reference)
    - LIFE TEST: 10,000 CYCLES .
    - OTHER GENERAL SPEC: TO REFER "MICRO USB GENERAL SERIES SPEC".
    - TO CONFORM TO THE SINGATRON HSF SPEC.
    - HALOGEN FREE PRODUCT IDENTIFICATION MARK ON PRODUCT.
    - HALOGEN FREE PRODUCT IDENTIFICATION LABEL ON PACKAGING.
    - FOR REFLOW SOLDERING LEAD-FREE PROCESS.
    - PLUG INTERFACE DIMENSIONS CONFORM TO USB2.0 SPEC.
    - PACKAGING: TAPE & REEL.

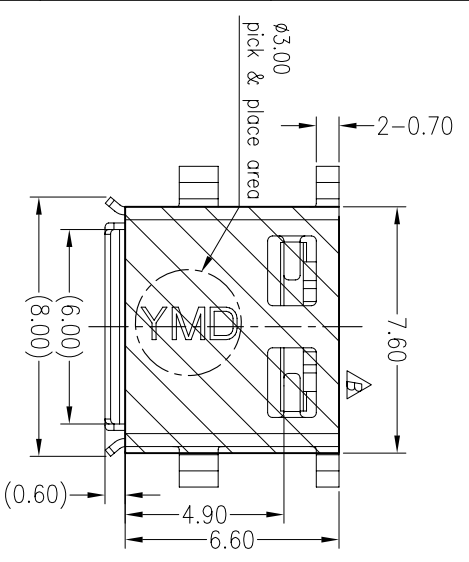
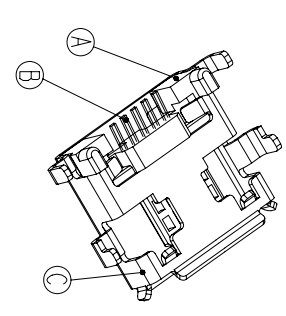
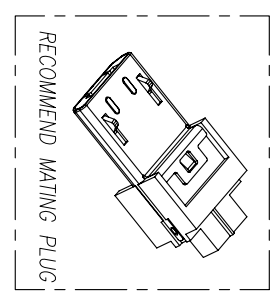
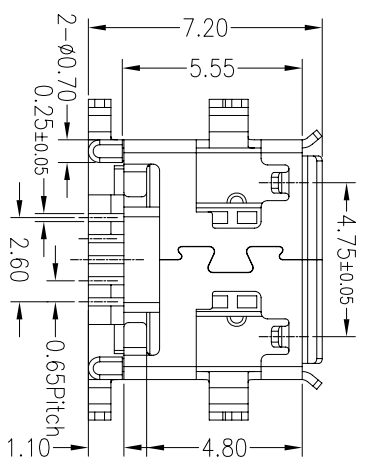
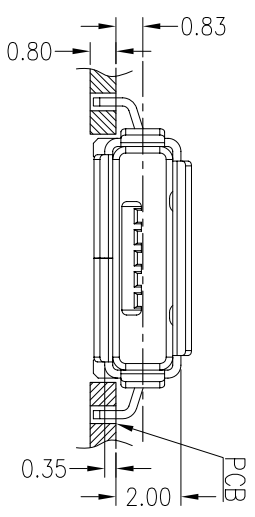
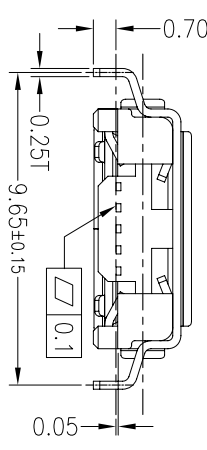
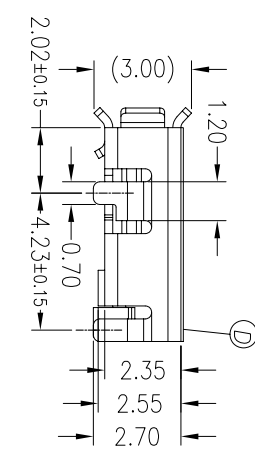
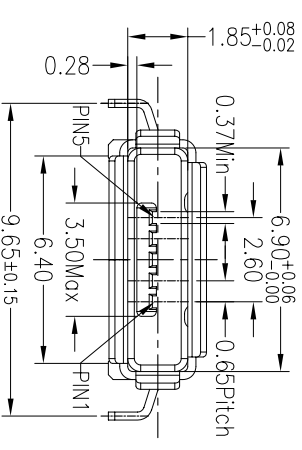

NO	DESCRIPTION	QTY	MATERIAL	PLATING & COLOR
D	MYLAR	1	MYLAR 0.075t	TRANSPARENT
C	SHELL	1	STAINLESS STEEL 0.25T	MATTE TIN
B	CONTACT	5	COPPER ALLOY 0.15T	Au 30u" ON CONTACT AREA GOLD FLASH ON SOLDER AREA All Over Nickel Plated
A	HOUSING	1	HI-TEMP. THERMO-PLASTIC UL94V-0	BLACK

UNLESS OTHERWISE SPECIFIED TOLERANCES

DECIMALS: ANGLES:

X :±0.5 X :±2°  
X.X :±0.3 X.X :±1°  
X.XX :±0.2

Singatron Enterprise Co., Ltd.  
信亨企業股份有限公司

TITLE: MICRO USB AB TYPE REVERSE RECEPTACLE

DWN: 20120313 PART NO. 2UB2018-000111F

CHKD: 20120313 SCALE: 4:1 UNIT: mm

APVD: 20120316 SIZE: A3 SHEET: 1 OF 1 REV: B

CUSTOMER COPY