

REV. ECN NO OR DESCRIPTION	REVISED	DATE
A PRODUCT RELEASE	Ares	2012.01.04

- SPECIFICATIONS:
1. ELECTRICAL CHARACTERISTICS:
- 1-1. RATING: 2A (PIN1/5), 0.5A (PIN2/3/4)
 - 1-2. CONTACT RESISTANCE: 30mΩ MAX.(INITIAL) 40mΩ MAX.(FINAL)
 - 1-3. DIELECTRIC WITHSTANDING VOLTAGE: 500V AC FOR ONE MINUTE.
 - 1-4. INSULATION RESISTANCE: 100MΩ MIN. MEASURED BY 500 VDC
2. MECHANICAL CHARACTERISTICS:
- 2-1. INSERTION FORCE : 3.6 KGF (MAX)
 - 2-2. WITHDRAWAL FORCE : 0.8 KGF(Reference)
3. LIFE TEST: 10,000 CYCLES .
4. TO CONFORM TO THE SINGATRON HSF SPEC.
5. HALOGEN FREE PRODUCT IDENTIFICATION MARK ON PRODUCT:
6. HALOGEN FREE PRODUCT IDENTIFICATION LABEL ON PACKAGING:
7. FOR REFLOW SOLDERING LEAD-FREE PROCESS.
8. THIS PRODUCT DELIVER TO 華寶 ONLY.
9. 所有端子須封孔處理
10. PACKAGING: TAPE & REEL.

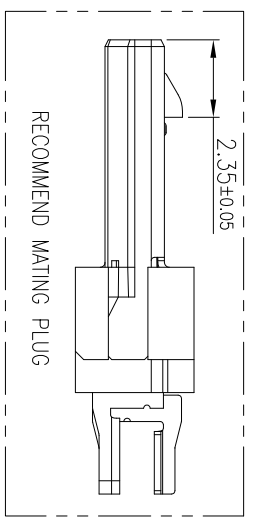
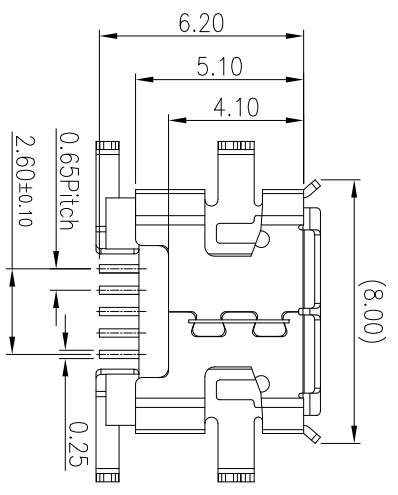
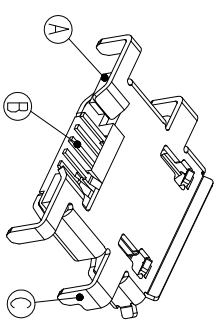
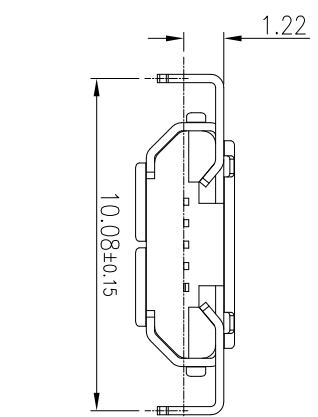
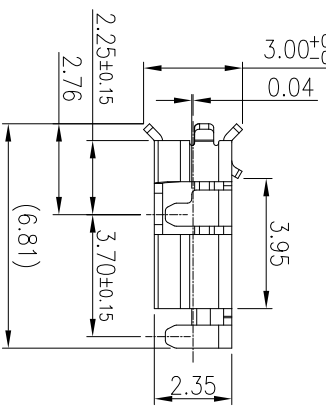
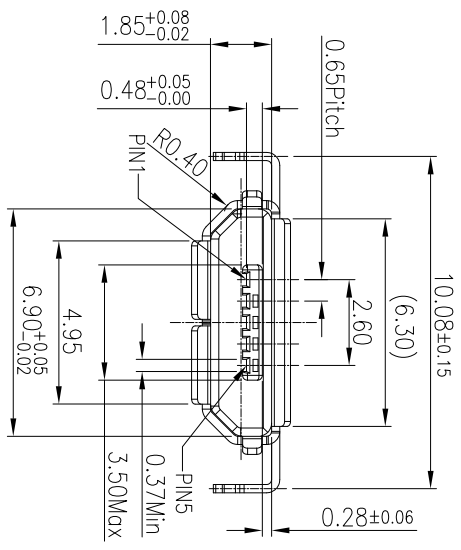
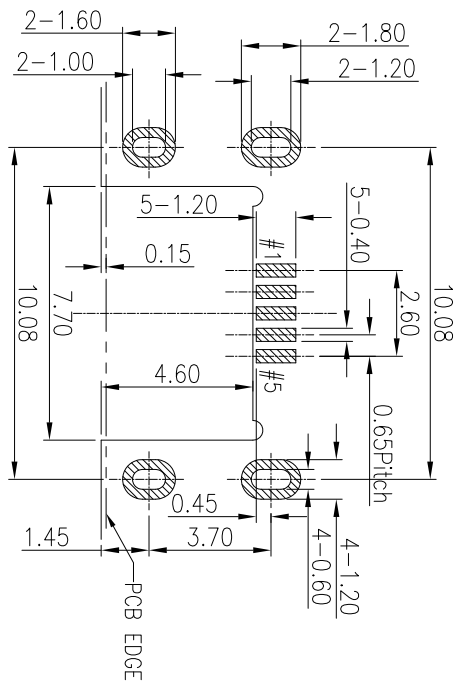

C	SHELL	1	STAINLESS STEEL 0.25T	MATTE TIN
B	CONTACT	5	COPPER ALLOY 0.15T	Au 30u" ON CONTACT AREA GOLD FLASH ON SOLDER AREA
A	HOUSING	1	HI-TEMP. THERMO-PLASTIC UL 94V-0	BLACK
NO	DESCRIPTION	QTY	MATERIAL	PLATING & COLOR

UNLESS OTHERWISE SPECIFIED TOLERANCES		SINGATRON ENTERPRISE CO., LTD. 信晉企業股份有限公司	
DECIMALS:	ANGLES:	MICRO USB B TYPE RECEPTACLE	
X : ±0.5	X : ±2°	DWN	Part No. 2UB2106-000111F
X.X : ±0.3	X.X : ±1°	CHKD	Scale 4:1 UNIT: mm
X.XX : ±0.2		APVD	SIZE: A3 SHEET: 1 OF 1 REV: A

CUSTOMER COPY