

REV.	ECN NO OR DESCRIPTION	REVISED	DATE
A	PRODUCT RELEASE	Ares	2012.12.26

- SPECIFICATIONS:
- ELECTRICAL CHARACTERISTICS:
 - RATING: 1.8A (PIN1/5), 0.5A (PIN2/3/4)
 - CONTACT RESISTANCE: 30mΩ MAX.(INITIAL)40mΩ MAX.(FINAL)
 - DIELECTRIC WITHSTANDING VOLTAGE: 500V AC FOR ONE MINUTE.
 - INSULATION RESISTANCE: 100M Ω·MIN. MEASURED BY 500 VDC
 - MECHANICAL CHARACTERISTICS:
 - INSERTION FORCE : 3.6 KGF (MAX)
 - WITHDRAWAL FORCE : 0.8 KGF(Reference)
 - LIFE TEST: 10,000 CYCLES .
 - TO CONFORM TO THE SINGATRON HSF SPEC.
 - HALOGEN FREE PRODUCT IDENTIFICATION MARK ON PRODUCT.
 - HALOGEN FREE PRODUCT IDENTIFICATION LABEL ON PACKAGING.
 - FOR REFLOW SOLDERING- LEAD-FREE PROCESS.
 - SOLDER HEAT RESISTANCE REFLOW SOLDERING: 260°C 10SECS.
 - PUG INTERFACE DIMENSIONS CONFORM TO USB2.0 SPEC.
 - PACKAGING: TAPE & REEL.

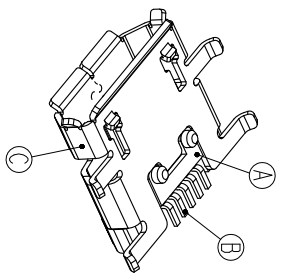
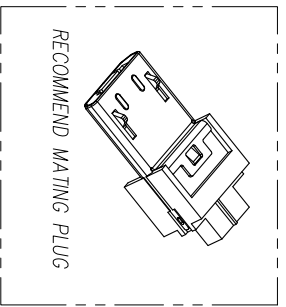
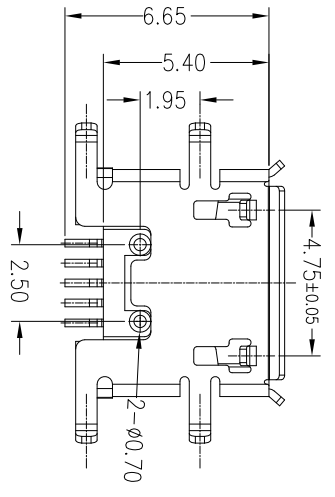
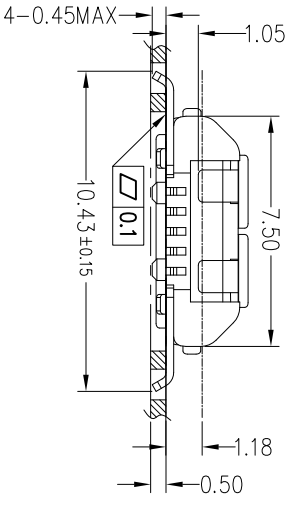
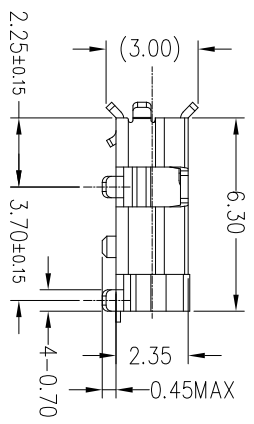
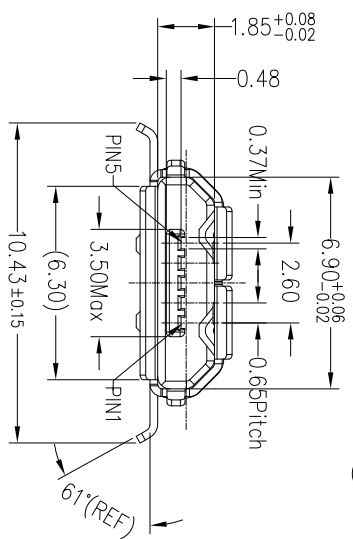
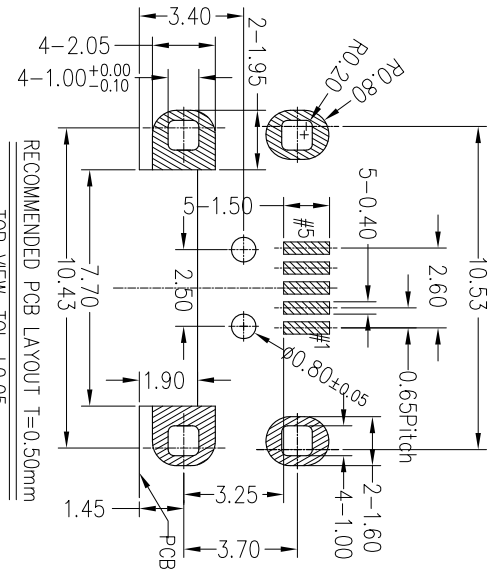
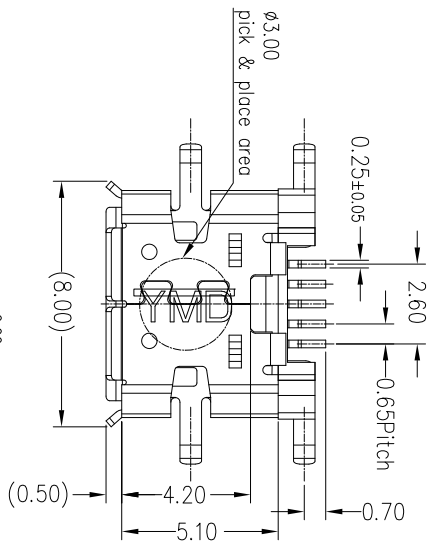

NO	DESCRIPTION	QTY	MATERIAL	PLATING & COLOR
C	SHELL	1	STAINLESS STEEL 0.25T	Au 3μ/Min ON SOLDER AREA Ni 50μ/Min PLATING ALL OTHER
B	CONTACT	5	COPPER ALLOY 0.15T	30μ Au ON CONTACT AREA GOLD FLASH ON SOLDER AREA ALL OTHER NICKEL PLATED
A	HOUSING	1	HI-TEMP. THERMO-PLASTIC UL94V-0	BLACK

NO	DESCRIPTION	QTY	MATERIAL	PLATING & COLOR
UNLESS OTHERWISE SPECIFIED TOLERANCES				
DECIMALS: ANGLES:				
X	:±0.5	X	:±2°	
X.X	:±0.3	X.X	:±1°	
X.XX	:±0.2			

TITLE	SCALE	UNIT	REV
MICRO USB B TYPE REVERSE RECEPTACLE	4:1	mm	A

APVD

Singatron Enterprise Co., Ltd.
信音企業股份有限公司

PART NO. 2UB2132-000111F

SCALE 4:1

UNIT: mm

SHEET: 1 OF 1

REV: A

CUSTOMER COPY