

REV.	ECN NO.	OR DESCRIPTION	REVISED	DATE
A		PRODUCT RELEASE	Stone	2017/05/12
B		ECN NO.:C170076	Lrq.Liu	2017/08/31

1.ELECTRICAL CHARACTERISTICS:

- 1-1.LICR :
 - VBUS&GND PINS:60mΩ /PIN MAX.
 - OTHER PINS:60mΩ /PIN MAX.
 - LLCR MAX. CHANGE OF ALL PINS:10mΩ.
- 1-2.CURRENT RATING:3.0A MAX.
- 1-3.VOLTAGE RATING:20.0V
- 1-4.INSULATION RESISTANCE:100MΩ MIN. BY 500V DC.
- 1-5.ENVIRONMENTAL PERFORMANCE:
 - OPERATING TEMPERATURE:-55℃~+85℃
- 2.MECHANICAL CHARACTERISTICS:
 - 2-1.INSERTION FORCE:0.5~2.0kg
 - 2-2.WITHDRAWAL FORCE:0.8~2.0kg(INITIAL VALUE)
0.6~2.0kg(AFTER LIFE TEST)
- 3.DURABILITY:10,000CYCLES
- 4.TO CONFORM TO THE SINGATRON HAZARDOUS SUBSTANCE FREE SPEC.
- 5.HALOGEN FREE PRODUCT IDENTIFICATION LABEL ON PACKAGING.
- 6.PACKAGE:SEE"2UB2C09-000111F"PACKAGE.
- 7.FOR REFLOW SOLDERING LEAD-FREE PROCESS
- 8.OTHER GENERAL SPEC.TO REFER"2UB2C09-000111F" SPEC."

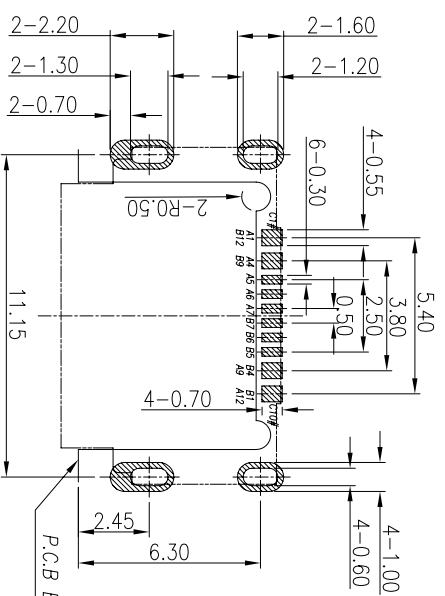
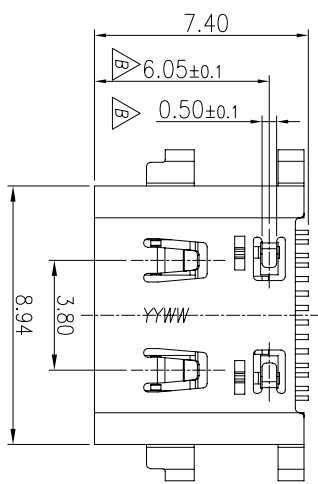

RECOMMENDED P.C.B LAYOUT
TOP VIEW,TOLERANCE : ±0.05mm

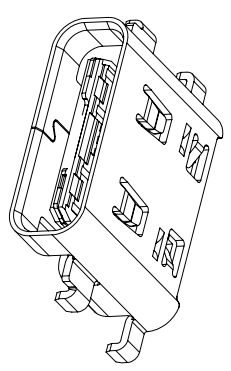
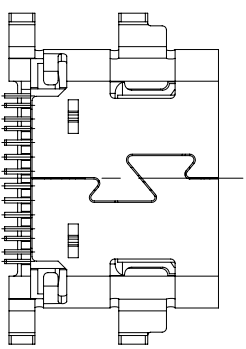
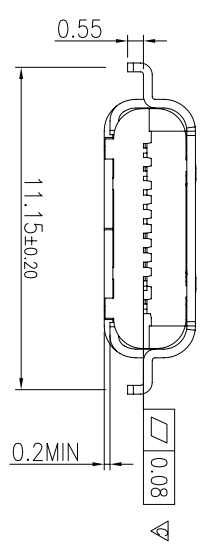
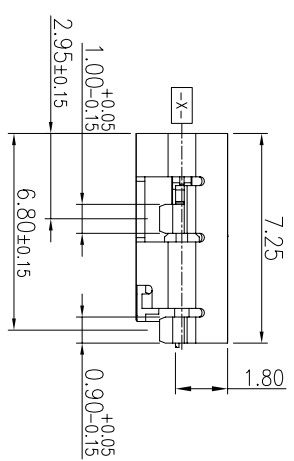
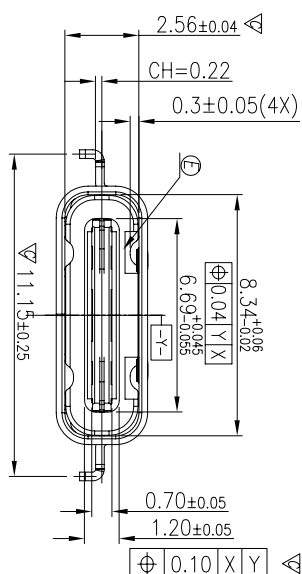

PIN ASSIGNMENTS:

PIN No.	SIGNAL NAME	PIN NUMBER
A1	GND	B12
A4	Vbus	B9
A5	CC1/CC2	B8
A6	Dp1/Dp2	B7
A7	Dn1/Dn2	B6
A9	Vbus	B4
A12	GND	B1

D	GND PLATE	1	STAINLESS STEEL	GOLD FLASH ON SOLDER TAIL
C	SHELL	1	STAINLESS STEEL	ALL OVER NICKEL PLATING
B	TERMINAL	14	COPPER ALLOY	AU 30N CONTACT AREA GOLD FLASH ON SOLDER TAIL ALL OVER Ni PLATING
A	HOUSING	1	HIGH TEMP. THERMOPLASTIC UL 94V-0	BLACK

Singatron Enterprise Co., Ltd.
信音企業股份有限公司

USB Type-C Connector

TITLE	REVISION	PART NO.	SCALE	UNIT	SIZE	SHEET	REV.
USB Type-C Connector	DWN	2UB2C09-000111F	1:1	mm	A3	1 OF 1	B