

REV.	ECN NO OR DESCRIPTION	REVISED	DATE
A	PRODUCT RELEASE	Shunzhong	2019.08.19

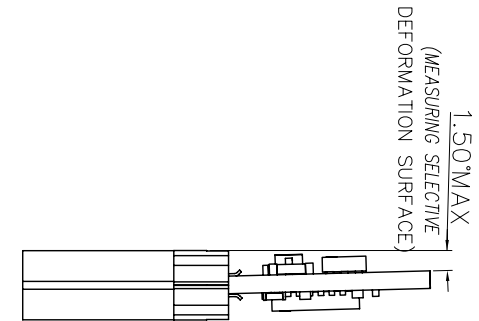

PCB PARALLELISM CONTROL

WIRE DIAGRAM

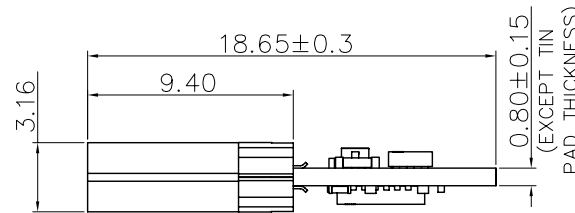
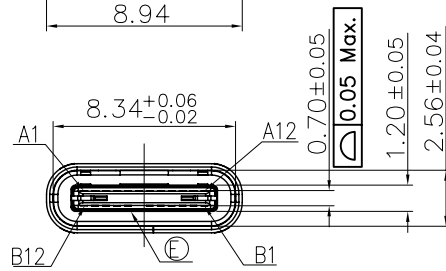
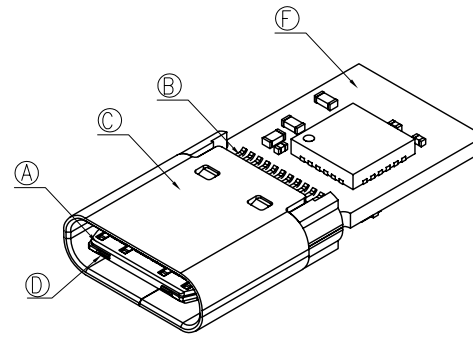
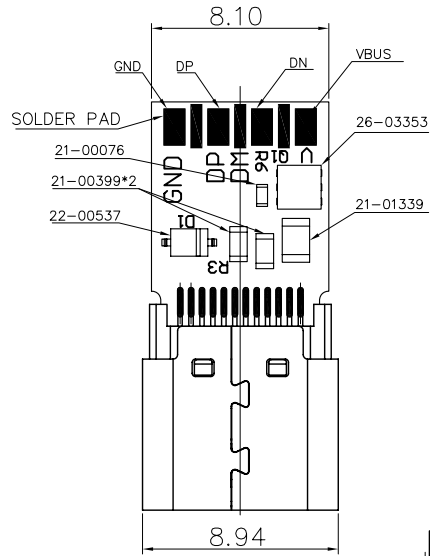
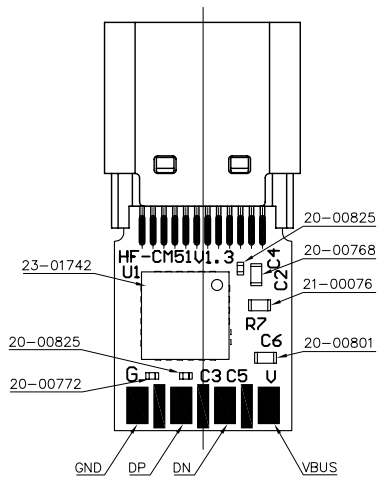
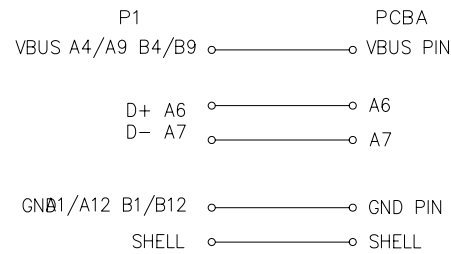

F	PCB	1	FR4													
E	GND RING	1	SUS304 1/2H 0.05T													
D	GND PLATE	1	SUS301 1/2H 0.2T													
C	SHELL	1	SUS304 1/2H 0.3T	NI 30u"MIN.												
B	TERMINAL	24	C1814-H 0.12T	AU 30u"ON CONTACT AREA AND Sn 50u"Min ON SOLDER AREA ALL OVER NICKEL 50u"Min PLATING												
A	HOUSING	1	LCP E6808 UL 94V-0	BLACK												
NO	DESCRIPTION	QTY	MATERIAL	PLATING & COLOR												
UNLESS OTHERWISE SPECIFIED TOLERANCES			Singatron Enterprise Co., Ltd. 信音企業股份有限公司													
DECIMALS:		ANGLES:	TITLE													
X	: ±0.5	X	: ±2°	DWN												
X.X	: ±0.3	X.X	: ±1°	CHKD												
X.XX	: ±0.2			APVD												
<table border="1"> <tr> <td>Shunzhong</td> <td>PART NO: 2UB2Y01-C00111F</td> <td></td> <td></td> </tr> <tr> <td>Stone-Zhu</td> <td>SCALE 1:1</td> <td>UNIT: mm</td> <td></td> </tr> <tr> <td>Jim-deng</td> <td>SIZE: A3</td> <td>SHEET: 10F1</td> <td>REV: A</td> </tr> </table>					Shunzhong	PART NO: 2UB2Y01-C00111F			Stone-Zhu	SCALE 1:1	UNIT: mm		Jim-deng	SIZE: A3	SHEET: 10F1	REV: A
Shunzhong	PART NO: 2UB2Y01-C00111F															
Stone-Zhu	SCALE 1:1	UNIT: mm														
Jim-deng	SIZE: A3	SHEET: 10F1	REV: A													
CUSTOMER COPY																

REV.	ECN NO OR DESCRIPTION	REVISED	DATE
A	PRODUCT RELEASE	Shunzhong	2019.08.19

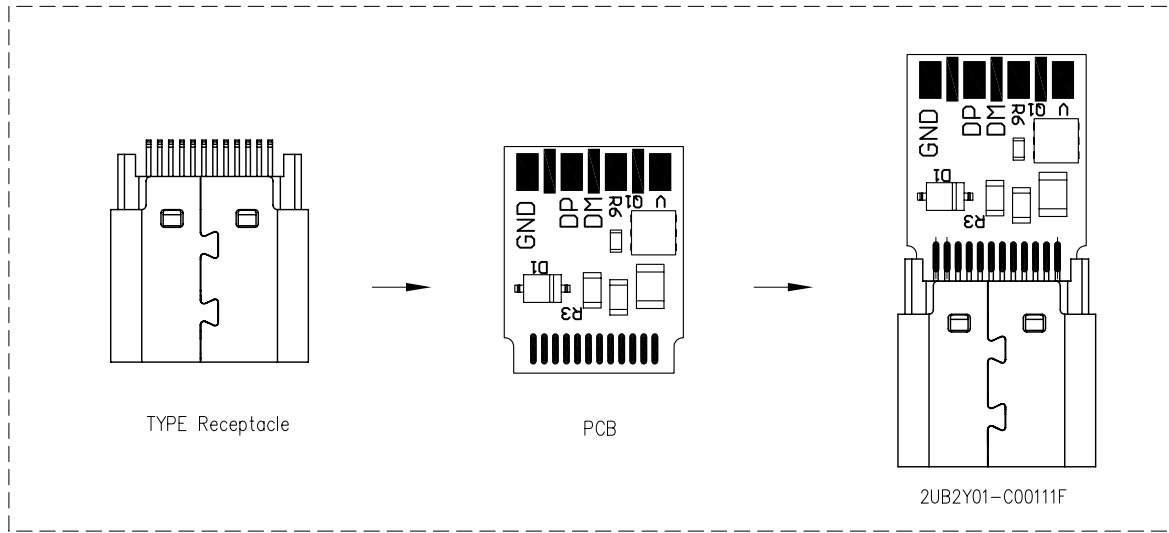

SPECIFICATIONS:

- ELECTRICAL CHARACTERISTICS:**
 - 1-1. RATING: 2A.
 - 1-2. CONTACT RESISTANCE: 40mΩ MAX.(INITIAL).
 - 1-3. INSULATION RESISTANCE: 100 MEGAOHMS MIN. BY 100V DC.
 - 1-4. DIELECTRIC WITHSTANDING VOLTAGE: 100V AC FOR 1 MINUTE.
- MECHANICAL CHARACTERISTICS:**
 - 2-1. INSERTION FORCE: 5~20N
 - 2-2. WITHDRAWAL FORCE: 8N~20N(INITIAL); 6~20N(AFTER TEST)
- LIFE TEST:** 10,000 CYCLES, 500 TIMES/HOUR .
- OTHER GENERAL SPEC.** TO REFER "USB TYPE C SERIES SPEC".
- TO CONFORM TO SINGATRON HAZARDOUS SUBSTANCE FREE SPEC.**
- HALOGEN FREE PRODUCT IDENTIFICATION MARK ON PRODUCT:**
- HALOGEN FREE PRODUCT IDENTIFICATION LABEL ON PACKAGING:**

ELECTRIC BOM LIST:

NO.	PART NUMBER	QTY	DESCRIPTION	BRAND
1	20-00768	1	CAP, X5R, 4.7uF, 0402, 10V, +/-10%	Murata
2	20-00772	1	CAP, X5R, 220nF, 0201, 10V, +/-10%	Murata
3	20-00825	2	CAP, X5R, 100nF, 0201, 25V, +/-10%	Murata
4	20-00801	1	CAP, X5R, 100nF, 0402, 50V, 10%	Murata
5	22-00537	1	DIODE, U-DIR V-SUP, SOD323, SD05	Diodes Inc
6	26-03353	1	TRANS, MOSFETN, DUAL, DMN3055LFDB (OR SSM6N57NU)	Diodes Inc
7	21-01339	1	RES, 0R02, 0805, 125mW, 1%	Ralec
8	21-00399	2	RES, 4k7,0603,100mW, 5%	Ralec
9	21-00076	2	RES, 10R, 0402, 63mW, 5%	Ralec
10	23-01742	1	IC, USB-C PD2.0 SOURCE CNTL, QFN24	Texas Instruments

NO	DESCRIPTION	QTY	MATERIAL	PLATING & COLOR
UNLESS OTHERWISE SPECIFIED TOLERANCES		Singatron Enterprise Co., Ltd. 信音企業股份有限公司		
DECIMALS:	ANGLES:	TITLE	USB C TYPE Receptacle with TI P.D IC	
X : ±0.5	X : ±2°	DWN	Shunzhong	PART NO: 2UB2Y01-C00111F
X.X : ±0.3	X.X : ±1°	CHKD	Stone-Zhu	SCALE 1:1 UNIT: mm
X.XX : ±0.2		APVD	Jim-deng	SIZE: A3 SHEET: 10F1 REV: A
CUSTOMER COPY				