

REV.	ECN NO OR DESCRIPTION	REVISED	DATE
A	PDR RELEASE	EVEN	2021.01.20

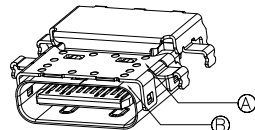
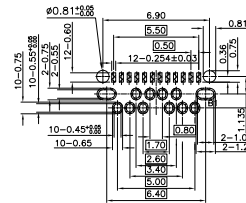
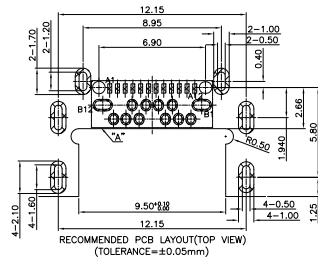
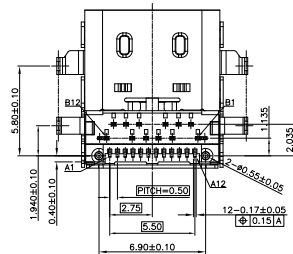
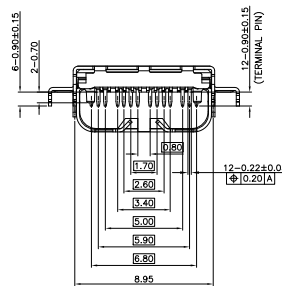
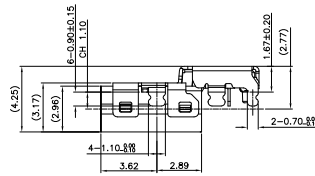
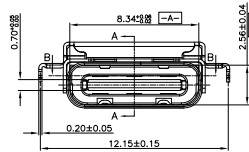
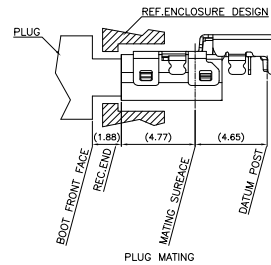
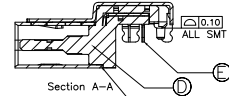
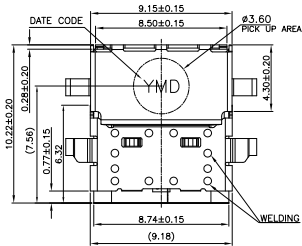

SPECIFICATIONS:

- ELECTRICAL CHARACTERISTICS:
 - CURRENT RATING: 5.0A
 - VOLTAGE RATING: 20.0 V
 - LLCR: VBUS & GND PINS: 40mΩ/PIN MAX
OTHER PINS : 40mΩ/PIN MAX
LLCR MAX. CHANGE OF ALL PINS: 10mΩ
 - INSULATION RESISTANCE: 100MΩ MIN
- MECHANICAL CHARACTERISTICS:
 - INSERTION FORCE: 5~20N.
 - WITHDRAWAL FORCE: 14~20N.(INITIAL:30/cycles) 8~20N.(AFTER LIFE TEST)
- DURABILITY: 10,000 CYCLES.
- TO CONFORM TO THE SINGATRON HAZARDOUS SUBSTANCE FREE SPEC.
- HALOGEN FREE PRODUCT IDENTIFICATION LABEL ON PACKAGING:
- PACKAGE: SEE "2UB3C02-214111F" PACKAGE.
- FOR REFLOW SOLDERING LEAD-FREE PROCESS.
- OTHER GENERAL SPEC. TO REFER "2UB3C02-214111F SPEC".

PART NO.
2UB3C02-214111F

- SUFFIX: HALOGEN FREE
- PACKAGE: 1: TAPE & REEL
- HOUSING COLOR: 1: BLACK
- CONTACT PLATING: 1: 30u" Au PLATING ON MATING AREA, GOLD FLASH ON SOLDERING AREA, 50u" MIN. NICKEL UNDER PLATING OVERALL

E	TERMINAL	24	C19400R-H	SEE PART NO.
D	SIGNAL	1	SUS 301	NICKEL PLATED 50u"MIN.
C	HOUSING	1	PA9T UL 94V-0	BLACK
B	INNER SHELL	1	SUS 301	NICKEL PLATED 50u"MIN.
A	OUTSIDE SHELL	1	SUS 301	NICKEL PLATED 50u"MIN.
NO	DESCRIPTION	QTY	MATERIAL	PLATING & COLOR

UNLESS OTHERWISE SPECIFIED TOLERANCES 信音科技(香港)有限公司

DECIMALS:	ANGLES:	TITLE	USB TYPE C , Mid-mount(CH=-1.10mm) C2		
X :±0.5	X :±2°	DWN	EVEN 2021.01.20	PART NO. 2UB3C02-214111F	
X.X :±0.3	X.X :±1°	CHKD		SCALE 1:1	UNIT: mm
X.XX :±0.2		APVD	ANGELA2021.01.20	SIZE: A3	SHEET:1 OF 2

CUSTOMER COPY

REV.	ECN NO OR DESCRIPTION	REVISED	DATE
A	PDR RELEASE	EVEN	2021.01.20

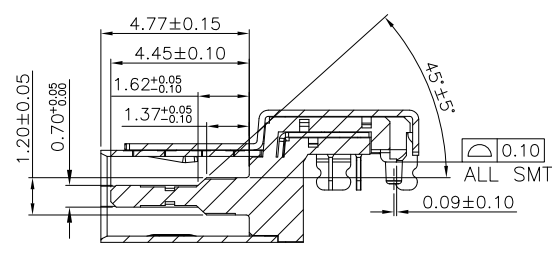
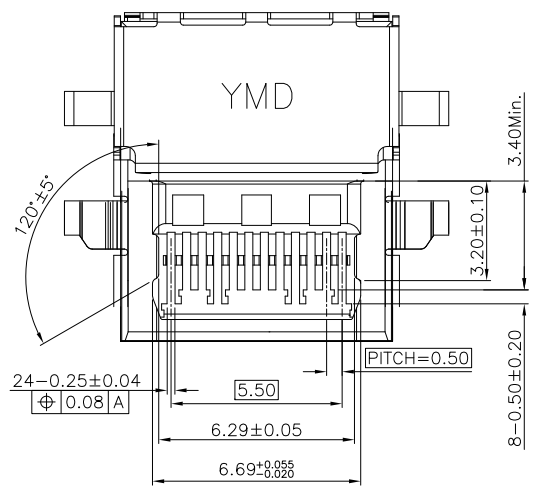

E	TERMINAL	24	C19400R-H	SEE PART NO.
D	SIGNAL	1	SUS 301	NICKEL PLATED 50u"MIN.
C	HOUSING	1	PA9T UL 94V-0	BLACK
B	INNER SHELL	1	SUS 301	NICKEL PLATED 50u"MIN.
A	OUTSIDE SHELL	1	SUS 301	NICKEL PLATED 50u"MIN.
NO	DESCRIPTION	QTY	MATERIAL	PLATING & COLOR

UNLESS OTHERWISE SPECIFIED TOLERANCES		信音科技(香港)有限公司		
DECIMALS:	ANGLES:	TITLE	USB TYPE C , Mid-mount(CH=-1.10mm) C2	
X :±0.5	X :±2°	DWN	EVEN 2021.01.20	PART NO. 2UB3C02-214111F
X.X :±0.3	X.X :±1°	CHKD	SCALE 1:1	UNIT: mm
X.XX :±0.2		APVD	ANGELA2021.01.20	SIZE: A3 SHEET: 2 OF 2 REV:A
CUSTOMER COPY				