

REV.	ECN NO.	OR DESCRIPTION	REVISED	DATE
B	ECN NO: L150144	IYY-C	2015.12.03	
C	ECN NO: L160023	IYY-C	2016.02.02	
D	ECN NO: L160031/84	IYY-C	2016.08.16	
E	ECN NO: L170010	EVEN	2017.06.03	
F	ECN NO: L201909-C04	IYY-C	2019.12.02	

- SPECIFICATIONS:**
- 1. ELECTRICAL CHARACTERISTICS:**
- 1-1. CURRENT RATING: 5.0A
  - 1-2. VOLTAGE RATING: 20.0 V
  - 1-3. ICLR: VBUS& GND PINS: 40mD/PIN MAX  
OTHER PINS : 40mD/PIN MAX
  - 1-4. ILCR MAX. CHANGE OF ALL PINS: 10mD
- 2. MECHANICAL CHARACTERISTICS:**
- 2-1. INSERTION FORCE: 0.5~2.0kg
  - 2-2. WITHDRAWAL FORCE: 1.4~2.0kg (INITIAL: 30/CYCLES) 0.6~2.0kg (AFTER LIFE TEST)
  - 3. DURABILITY: 10 000 CYCLES
  - 4. TO CONFORM TO THE SINGATRON HAZARDOUS SUBSTANCE FREE SPEC.
  - 5. HALOGEN FREE PRODUCT IDENTIFICATION LABEL ON PACKAGING
  - 6. PACKAGE: SEE "SUB3C03-000111F" PACKAGE.
  - 7. FOR REFLOW SOLDERING LEAD-FREE PROCESS.
  - 8. OTHER GENERAL SPEC. TO REFER "SUB3C03-000111F" SPEC.

**PART NO.**  
**SUB3C03-000111F**

- SUFFIX: HALOGEN FREE
- PACKAGE
- 1: TAPE & REEL
- HOUSING COLOR
- 1: BLACK
- CONTACT PLATING
- 1: 30u" Au ON MATING AREA.
- MATTE Sn 60~150u" ON SOLDERING AREA.
- 50u" MIN. NICKEL UNDER PLATING OVERALL

NO	DESCRIPTION	QTY	MATERIAL	PLATING & COLOR
A	OUTSIDE SHELL	1	SUS301	NICKEL PLATED 60u"MIN. MATTE Sn 300 MIN. ON SOLDERING AREA 60u"MIN/NICKEL UNDERPLATED
B	INNER SHELL	1	SUS301	BLACK
C	HOUSING	1	LCP UL 94V-0	BLACK
D	SIGNAL	1	SUS301	NICKEL PLATED 50u"MIN.
E	RFI PAD	2	SUS301	NICKEL PLATED 50u"MIN.
F	TERMINAL	24	C1940	SEE PART NO.
G	INK			BLACK

UNLESS OTHERWISE SPECIFIED TOLERANCES

DECIMALS: ANGLES:

X :±0.5 X :±2°

X.X :±0.3 X.X :±1°

X.XX :±0.2 X.XX :±0.2

**Singatron Enterprise Co., Ltd.**  
**信登企業股份有限公司**

USB TYPE C, Mid-mount(CH=0.58mm)

PART NO. SUB3C03-000111F

SCALE 1:1 UNIT: mm

SHEET: 1 OF 2 REV: F

**CUSTOMER COPY**

REV.	ECN NO.	OR DESCRIPTION	REVISED	DATE
B	ECN NO: L150144		IYY-C	2015.12.03
C	ECN NO: L160023		IYY-C	2016.02.02
D	ECN NO: L160031/84		IYY-C	2016.08.16
E	ECN NO: L170010		EVEN	2017.06.03
F	ECN NO: L201909-C04		IYY-C	2019.12.02

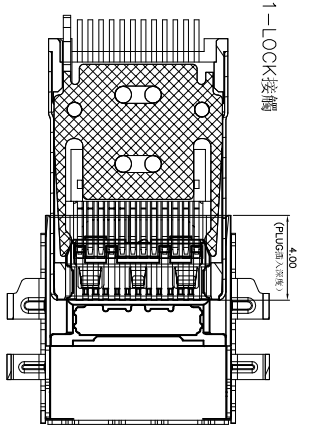

1-LOCK接觸

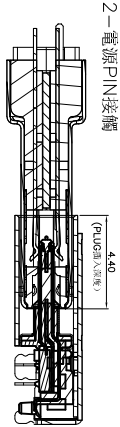

2-電源PIN接觸

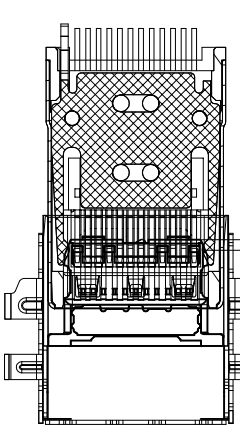

3-信號PIN&RF PAD接觸

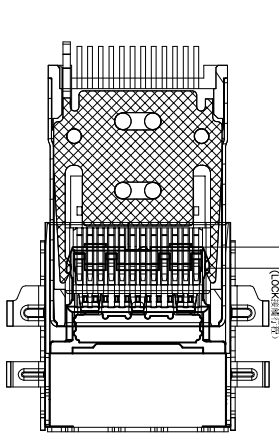

4-LOCK 狀態

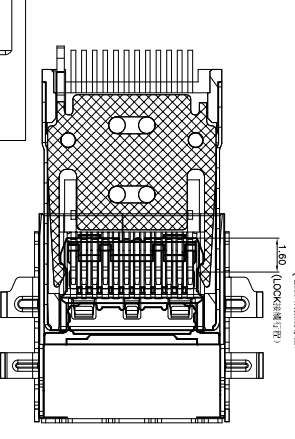

5-PLUG插入到底狀態

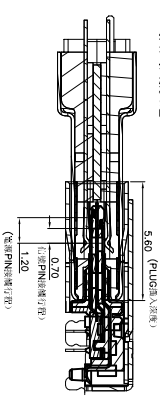

USB TYPE-C PIN ASSIGNMENTS:

PIN	SIGNAL NAME	PIN	SIGNAL NAME
A12	GND	B1	GND
A11	SSRXp2	B2	SSTXP2
A10	SSRXn2	B3	SSTXn2
A9	VBUS	B4	VBUS
A8	SBU1	B5	CC2
A7	Dn1	B6	Dp2
A6	Dp1	B7	Dn2
A5	CC1	B8	SBU2
A4	VBUS	B9	VBUS
A3	SSTXn1	B10	SSRXn1
A2	SSTXP1	B11	SSRXp1
A1	GND	B12	GND

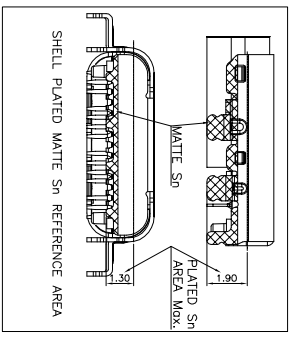

NO	DESCRIPTION	QTY	MATERIAL	PLATING & COLOR
UNLESS OTHERWISE SPECIFIED TOLERANCES				
DECIMALS:		ANGLES:		
X	:±0.5	X	:±2°	
X.X	:±0.3	X.X	:±1°	
X.XX	:±0.2			
TITLE: USB TYPE C, Mid-mount(CH=0.58mm)				
DWN	REV: 2019.12.02	PART NO. 2UB3C03-000111F		
CHKD	ANG: 2019.12.02	SCALE: 1:1	UNIT: mm	
APVD	ANG: 2019.12.02	SIZE: A3	SHEET: 2 OF 2	REV: F

CUSTOMER COPY