

REV.	ECN NO OR DESCRIPTION	REVISED	DATE
A	PDR RELEASE	IVY-C	2016.05.10
B	ECN NO: L160084	IVY-C	2016.08.16

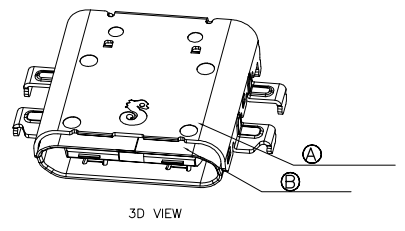
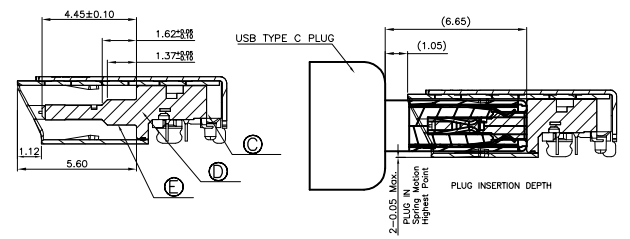
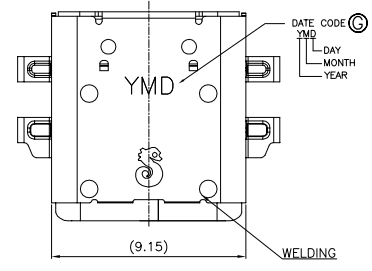

3D VIEW

SPECIFICATIONS:

- ELECTRICAL CHARACTERISTICS:
 - CURRENT RATING: 3.0A
 - VOLTAGE RATING: 20.0 V
 - LLCR: VBUS& GND PINS: 40mΩ/PIN MAX
OTHER PINS : 40mΩ/PIN MAX
LLCR MAX. CHANGE OF ALL PINS: 10mΩ
 - INSULATION RESISTANCE: 100MΩ MIN
- MECHANICAL CHARACTERISTICS:
 - INSERTION FORCE: 0.5~2.0kg.
 - WITHDRAWAL FORCE: 0.8~2.0kg,(INITIAL 1000 CYCLES) 0.6~2.0kg,(AFTER LIFE TEST)
- DURABILITY: 10,000 CYCLES.
- TO CONFORM TO THE SINGATRON HAZARDOUS SUBSTANCE FREE SPEC.
- HALOGEN FREE PRODUCT IDENTIFICATION LABEL ON PACKAGING:
- PACKAGE: SEE "2UB3C03-111111F" PACKAGE.
- FOR REFLOW SOLDERING LEAD-FREE PROCESS.
- OTHER GENERAL SPEC. TO REFER "2UB3C03-111111F SPEC".

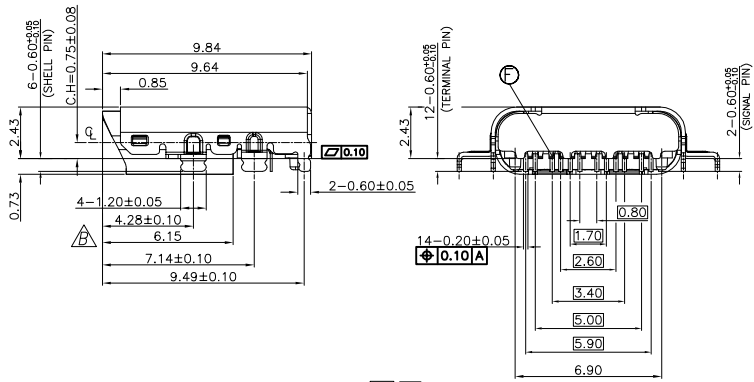
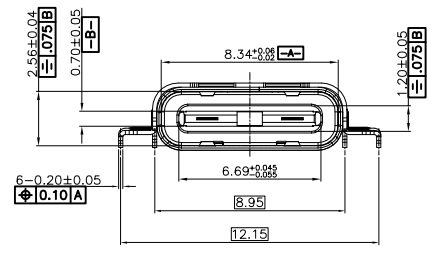

PART NO.
2UB3C03-111111F

- 1: CH=0.75mm
- CONTACT TALL LENGTH: 1: 0.60mm
- SUFFIX: HALOGEN FREE
- PACKAGE: 1: TAPE & REEL
- HOUSING COLOR: 1: BLACK
- CONTACT PLATING: 1: 30u" Au ON MATING AREA, MATTE Sn 60~150u" ON SOLDERING AREA, 80~150u" NICKEL UNDER PLATING OVERALL

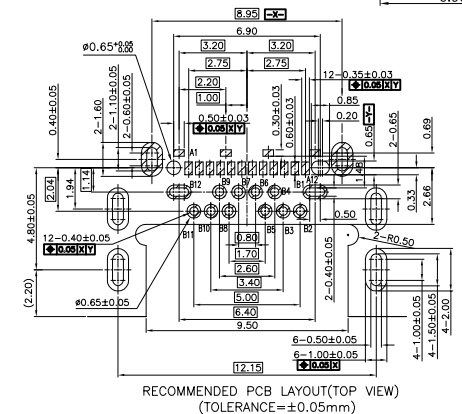
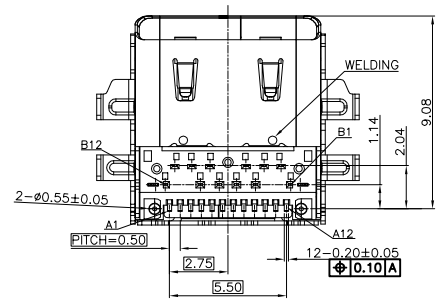

RECOMMENDED PCB LAYOUT(TOP VIEW)
(TOLERANCE=±0.05mm)

G	INK			BLACK
F	TERMINAL	24	COPPER ALLOY	SEE PART NO.
E	RFI PAD	2	STAINLESS STEEL	NICKEL
D	SIGNAL	1	STAINLESS STEEL	NICKEL
C	HOUSING	1	LCP UL 94V-0	BLACK
B	INNER SHELL	1	STAINLESS STEEL	NICKEL
A	OUTSIDE SHELL	1	STAINLESS STEEL	MATTE Sn 60~150u" ON SOLDERING AREA, NICKEL UNDERPLATED 50u" MIN.
NO	DESCRIPTION	QTY	MATERIAL	PLATING & COLOR

UNLESS OTHERWISE SPECIFIED TOLERANCES

Singatron Enterprise Co., Ltd.
信音企業股份有限公司

DECIMALS: ANGLES:
X :±0.5 X :±2°
X.X :±0.3 X.X :±1°
X.XX :±0.2

TITLE	USB TYPE C , Mid-mount(CH=0.75mm)		
DWN	IVY-C 2016.08.16	PART NO.	2UB3C03-111111F
CHKD	ANGELA2016.08.16	SCALE	1:1 UNIT: mm
APVD	ANGELA2016.08.16	SIZE: A3	SHEET: 1 OF 1 REV: B

CUSTOMER COPY