

REV.	ECN NO OR DESCRIPTION	REVISED	DATE
A	PDR RELEASE	EVEN	2021.04.08

SPECIFICATIONS:

- ELECTRICAL CHARACTERISTICS:**
 - CURRENT RATING: 5.0A
 - VOLTAGE RATING: 20.0 V
 - LLCR: VBUS& GND PINS: 40mΩ/PIN MAX
OTHER PINS : 40mΩ/PIN MAX
LLCR MAX. CHANGE OF ALL PINS: 10mΩ
 - INSULATION RESISTANCE: 100MΩ MIN
- MECHANICAL CHARACTERISTICS:**
 - INSERTION FORCE: 0.5~2.0kg.
 - WITHDRAWAL FORCE: 0.8~2.0kg.(INITIAL 1000 CYCLES) 0.6~2.0kg.(AFTER LIFE TEST)
- DURABILITY:** 10,000 CYCLES.
- TO CONFORM TO THE SINGATRON HAZARDOUS SUBSTANCE FREE SPEC.
- HALOGEN FREE PRODUCT IDENTIFICATION LABEL ON PACKAGING: 
- PACKAGE: SEE "2UB3C03-203111F" PACKAGE.
- FOR REFLOW SOLDERING LEAD-FREE PROCESS.
- OTHER GENERAL SPEC. TO REFER "2UB3C03-203111F SPEC".

PART NO.
2UB3C03-203111F

- 2: CH=0.60mm
- SUFFIX: HALOGEN FREE
- PACKAGE: 1: TAPE & REEL
- HOUSING COLOR: 1: BLACK
- CONTACT PLATING: 1: 30u" Au ON MATING AREA, MATTE Sn 60u" MIN. ON SOLDERING AREA, 50u" MIN.NICKEL UNDER PLATING OVERALL

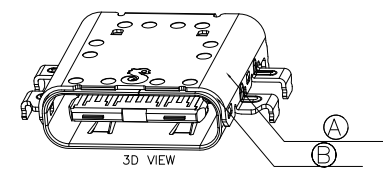
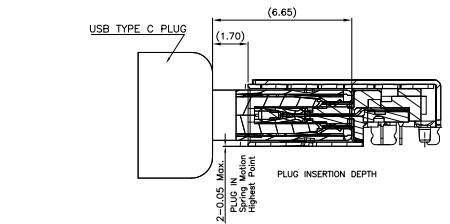
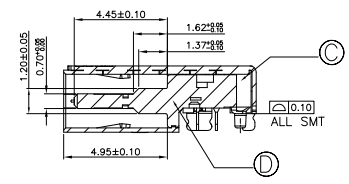
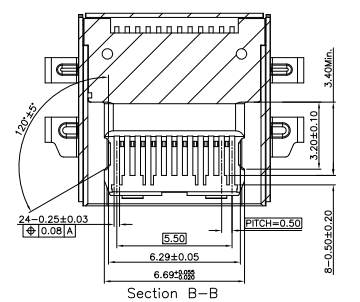
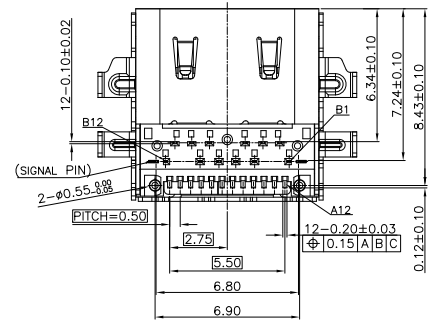
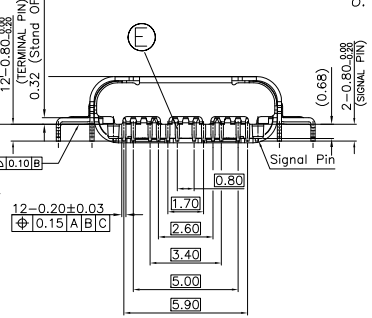
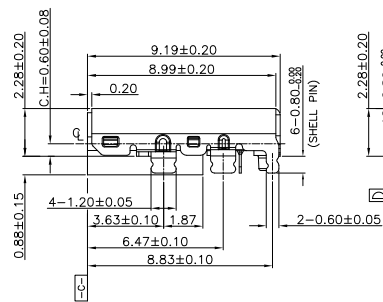
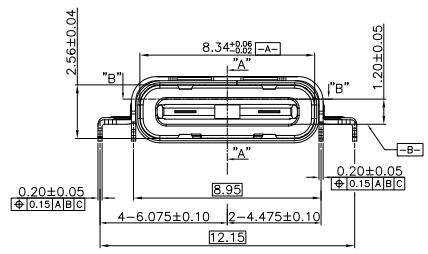
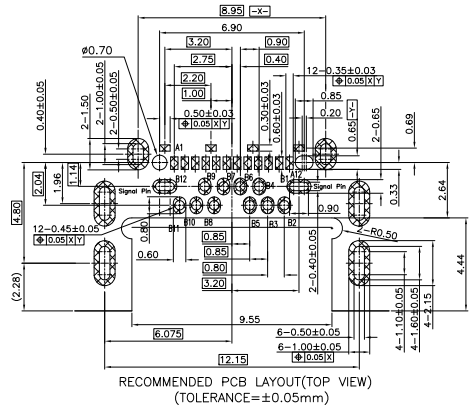
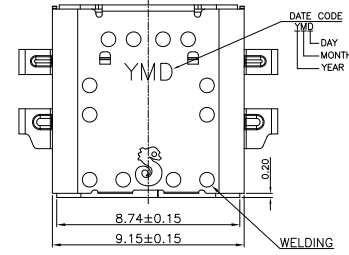

E	TERMINAL	24	C19400	SEE PART NO.
D	SIGNAL	1	SUS301	
C	HOUSING	1	LCP UL 94V-0	BLACK
B	INNER SHELL	1	SUS301	50u"Min.NICKEL
A	OUTSIDE SHELL	1	SUS301	50u"Min.NICKEL
NO	DESCRIPTION	QTY	MATERIAL	PLATING & COLOR

UNLESS OTHERWISE SPECIFIED TOLERANCES

 信音科技(香港)有限公司

DECIMALS:	ANGLES:	TITLE	USB TYPE C , Mid-mount(CH=0.60mm)		
X :±0.5	X :±2°	DWN	EVEN 2021.04.08	PART NO. 2UB3C03-203111F	
X.X :±0.3	X.X :±1°	CHKD		SCALE 1:1	UNIT: mm
X.XX :±0.2		APVD	ANCELA2021.04.08	SIZE: A3	SHEET:1 OF 2

CUSTOMER COPY

REV.	ECN NO OR DESCRIPTION	REVISED	DATE
A	PDR RELEASE	EVEN	2021.04.08

1-LOCK接觸

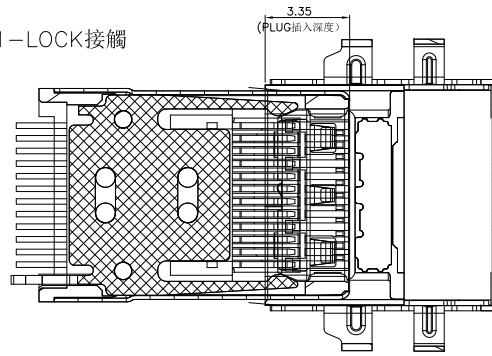

2-電源PIN接觸

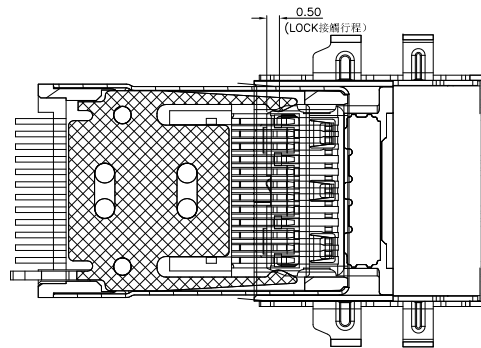
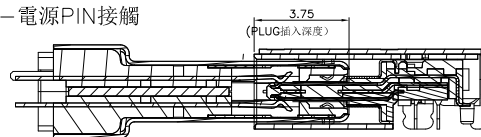

3-信號PIN&RF PAD接觸

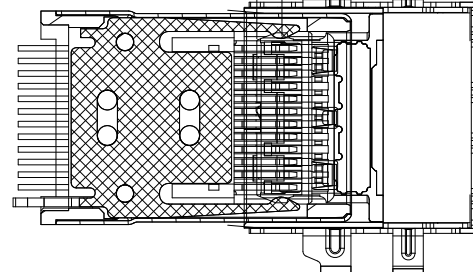
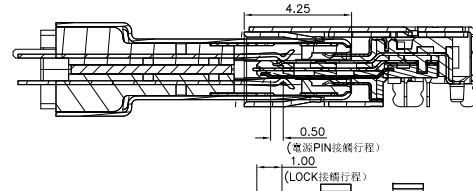

4-LOCK 狀態

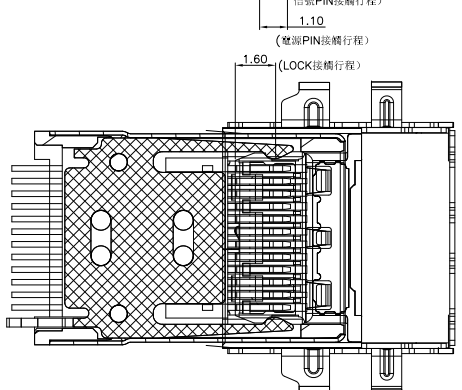
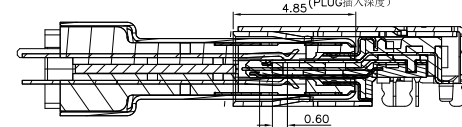

5-PLUG插到底狀態

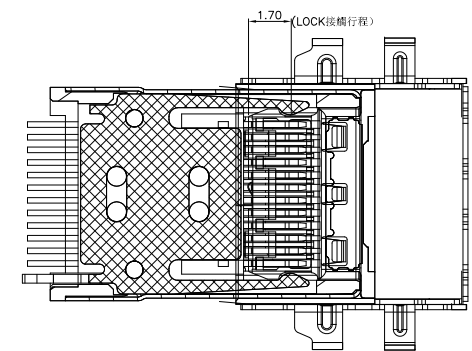
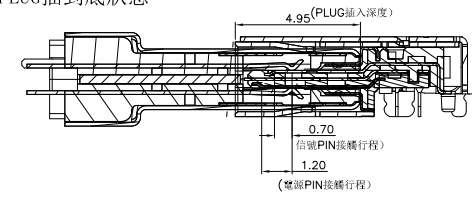

NO	DESCRIPTION	QTY	MATERIAL	PLATING & COLOR
UNLESS OTHERWISE SPECIFIED TOLERANCES		 信音科技(香港)有限公司		
DECIMALS:	ANGLES:	TITLE	USB TYPE C , Mid-mount(CH=0.60mm)	
X :±0.5	X :±2°	DWN	EVEN 2021.04.08	PART NO. 2UB3C03-203111F
X.X :±0.3	X.X :±1°	CHKD	SCALE 1:1	UNIT: mm
X.XX :±0.2		APVD	SIZE: A3	SHEET: 2 OF 2 REV:A
CUSTOMER COPY				