

REV.	ECN NO OR DESCRIPTION	REVISED	DATE
A	PDR NO:T171017-2A	peng	2018.01.16

ø4.5mm AVAILABLE VACUUM PICK UP AREA

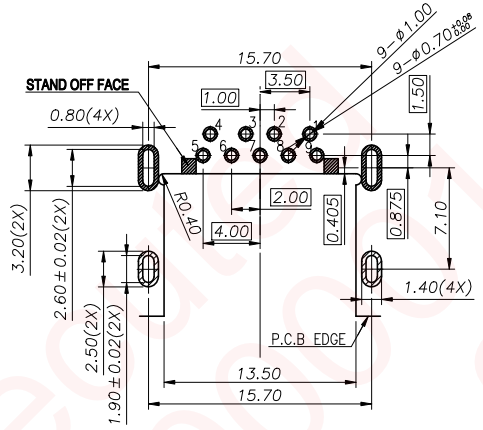
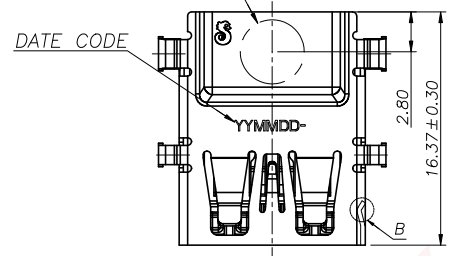

Recommended P.C.B Layout (THICKNESS=1.2mm)
(Component Side) TOLERANCE=±0.03 TOP VIEW

SPECIFICATIONS:

- ELECTRICAL CHARACTERISTICS:
 - CURRENT RATING: 1.8A (PIN1,4) ; OTHER CONTACTS 0.25A
 - CONTACT RESISTANCE: 30mΩ MAX.
 - DIELECTRIC WITHSTANDING VOLTAGE: 100V AC FOR 1 MINUTE
 - INSULATION RESISTANCE: 100MΩ MIN
- MECHANICAL CHARACTERISTICS:
 - INSERTION FORCE : 3.5 Kgf MAX
 - WITHDRAWAL FORCE : 1.0~2.2Kgf (INITIAL),0.8~2.2Kgf (AFTER TEST)
- DURABILITY: 5,000 CYCLES.
- TO CONFORM TO SINGATRON HAZARDOUS SUBSTANCE FREE SPEC.
- HALOGEN FREE IDENTIFICATION MARK ON JACK: Ⓞ
- HALOGEN FREE IDENTIFICATION LABEL ON PACKAGING:
- FOR IR REFLOW PROCESS.
- DATE : YYMMDD-
- PACKAGING : TAPE & REEL.

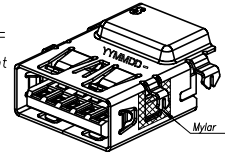
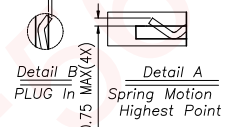
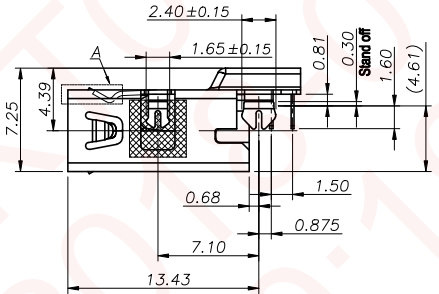
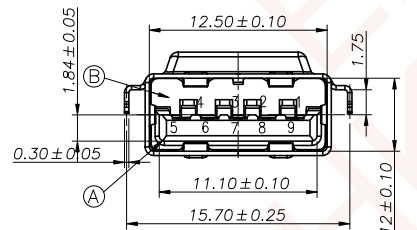

Pin Number	Signal NAME
1	VBUS
2	D-
3	D+
4	GND
5	StdA_SSRX-
6	StdA_SSRX+
7	GND_DRAIN
8	StdA_SSTX-
9	StdA_SSTX+

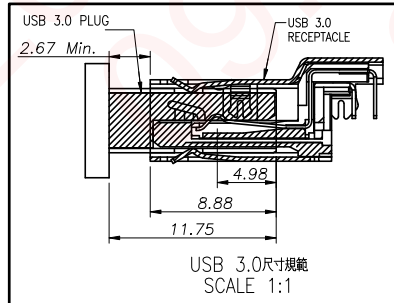
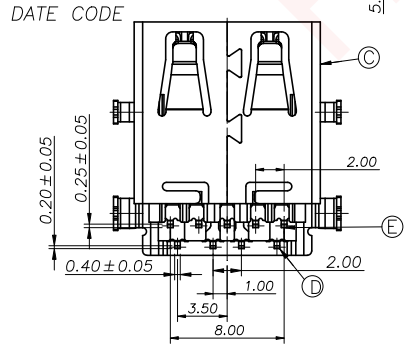

F	MYLAR	2	KAPTON 4.0*4.0
E	TERMINAL	5	C2680 T0.25
D	TERMINAL	4	C5210 T0.20
C	SHELL	1	SUS 304-1/2H 0.30T NICKEL 60µin MIN
B	BASE	1	PA4T UL94V-0 BLACK
A	HOUSING	1	PA4T UL94V-0 BLACK
NO	DESCRIPTION	QTY	MATERIAL PLATING & COLOR
UNLESS OTHERWISE SPECIFIED TOLERANCES		Singatron Enterprise Co., Ltd. 信音企業股份有限公司	
DECIMALS:	ANGLES:	TITLE	
X : ±0.5	X : ±2°	USB 3.0 REVERSE CONNECTOR	
X.X : ±0.3	X.X : ±1°	DWN	peng PART NO.2UB4055-100201F
X.XX : ±0.2		CHKD	james SCALE 1:1 UNIT: mm
		APVD	boye SIZE: A3 SHEET:1 OF 1 REV:A
CUSTOMER COPY			