

REV	ECN No.	DATE	REMARK
A		2019.02.18	NEW RELEASE
B		2019.03.05	修正BOM表

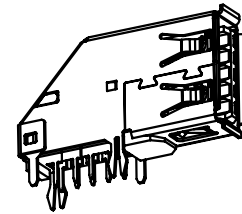
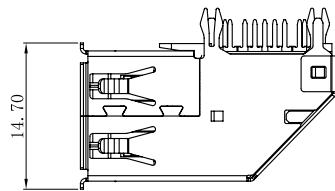

NOTES:

1. ELECTRONIC:

CONTACT RESISTANCE: 30mohm MAX
 INSULATION RESISTANCE: 1000 Mohm MIN
 WITHSTAND VOLTAGE: AC 500V, 1min.

2. MECHANICAL:

DURABILITY: 5000 CYCLE.

3. ENVIRONMENT CHARACTERISTICS:

OPERATING TEMPERATURE: -55° C TO +105° C

4. RECOMMANDER PCB THICKNESS 1.2 TO 1.60MM

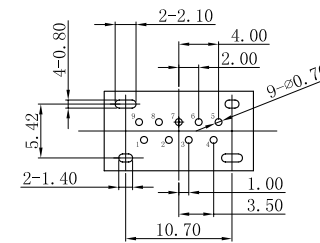
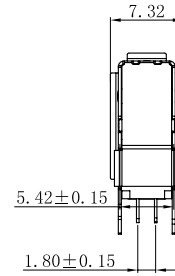
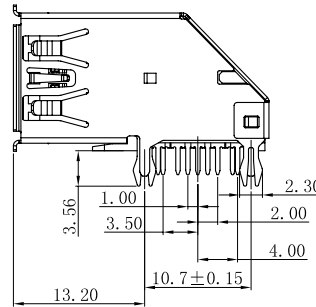
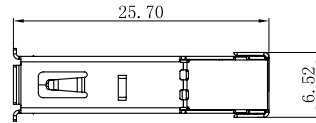
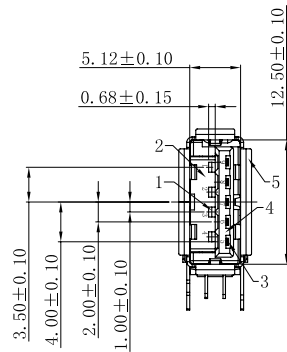

PCB LAYOUT (TOP VIEW)

Pin NUMBER	SIGNAL NAME
1	VBUS
2	D-
3	D+
4	GND
5	StdA_SSRX-
6	StdA_SSRX+
7	GND_DRAIN
8	StdA_SSTX-
9	StdA_SSTX+
Shell	Shield

5	SHELL	SUS201	1	AU 1u" PLATED
3	CONTACT 2#	COPPER ALLOY	5	GOLD/TIN PLATED
4	CONTACT 1#		4	Ep/Sn Sn 100u"Min EP/Au AU 1u"
2/7	HOUSING	LCP BLUE	1	UL94V-0
NO.	DESCRIPTION	MATERIAL	QTY.	REMARK

QUALITY SYMBOL	GENERAL TOLERANCES (UNLESS SPECIFIED)
0	x.xxxx ± ---
0	x.xxx ± ---
0	x.xx ± 0.25
0	x.x ± 0.30
0	ANGULAR ± ---

Singatron Enterprise Co., Ltd.			
TITLE	USB3.0 AF 90度侧插 DIP 鱼叉脚卷边		
DWN	2019/02/18	SLF	PART NO. 2UBF01-120200-0079
CHKD	2019/02/18	UOVID	SCALE 1:1 UNIT: mm
APVD	2019/02/18	UOVID	SIZE: A3 SHEET: 1 OF 1 REV: B
CUSTOMER COPY			