

P/N LEGEND

2WBA2501 WV-XP N 0 X T1 N XX G

① Series No.
 ② Connector type: WV=Vertical
 ③ No. of circuits
 ④ N=Halogen Free
 ⑤ Material: 0=Nylon 66-V0
 ⑥ Color: W=White,B=Black
 ⑦ Plating code for contacts: T1=Tin-plated
 ⑧ Plating code: N=Non-plating
 ⑨ Option code:
 KO=With pin kink; 00=Without pin kink
 ⑩ Packing code: G=Bag

SPECIFICATIONS
 Current Rating: 3A AC,DC
 Voltage Rating: 250V AC,DC
 Temperature Range: -25°C ~ +85°C
 Contact Resistance: 10mΩ Max
 Insulation Resistance: 1000MΩ Min
 Withstanding Voltage: 1000V AC/minute
 Pin Material: Brass/Tin-plated
 Material: Nylon 66, UL94V-0
 Color: White/Black

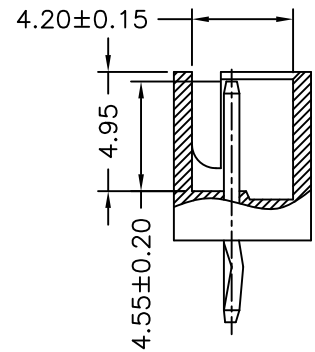
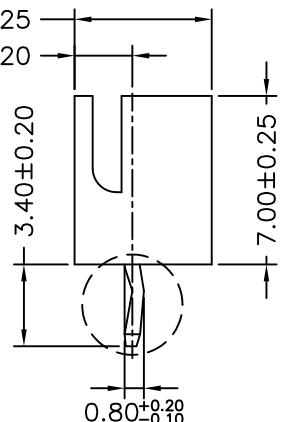
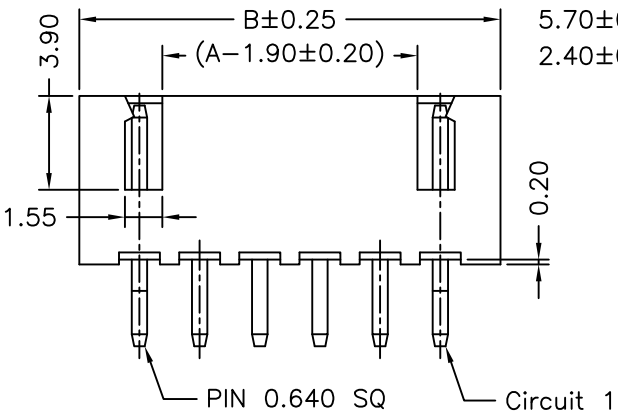
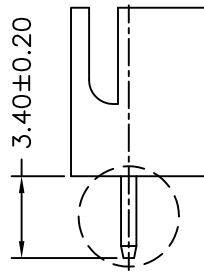
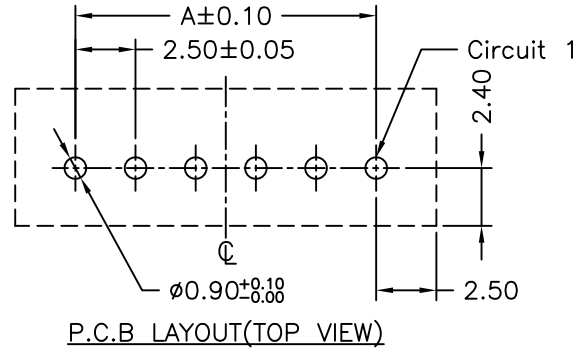
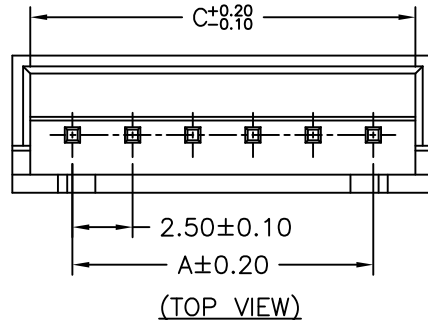

Circuit No.	Dimensions			Circuit No.	Dimensions		
	A	B	C		A	B	C
02P	2.50	7.50	6.00	12P	27.50	32.50	31.00
03P	5.00	10.00	8.50	13P	30.00	35.00	33.50
04P	7.50	12.50	11.00	14P	32.50	37.50	36.00
05P	10.00	15.00	13.50	15P	35.00	40.00	38.50
06P	12.50	17.50	16.00	16P	37.50	42.50	41.00
07P	15.00	20.00	18.50	17P	40.00	45.00	43.50
08P	17.50	22.50	21.00	18P	42.50	47.50	46.00
09P	20.00	25.00	23.50	19P	45.00	50.00	48.50
10P	22.50	27.50	26.00	20P	47.50	52.50	51.00
11P	25.00	30.00	28.50				

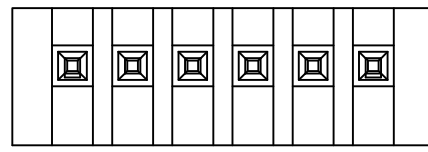

A3	EN1504280003	2015.04.28	黃培軍	GENERAL TOLERANCE	ANGLE±
A2	EN1401240004	2014.01.22	郭木思		
A1	EN1301030004	2013.01.03	郭木思		
A0	NEW RELEASE	2011.08.08	陳敏		
REV.	DESCRIPTION	DATE	NAME	X.X±0.25	ANGLE±
				X.XX±0.15	
				X.XXX±0.05	

Singatron Enterprise Co., Ltd.			
TITLE	2.50mm PITCH 180° WAFER		
DWN	陳敏	PART NO.	2WBA2501WV-XPXXXXXXXXXX
CHKD	2011.08.08	SCALE 1:1	UNIT: mm
APVD	董正一	SIZE: A3	SHEET:1 OF 1 REV: A3
CUSTOMER COPY			