

REV.	ECN NO OR DESCRIPTION	REVISED	DATE
A	PDR NO.T131119-6A	Dak	2014.06.02
B	ECN NO.S161234-C	YUREN	2017.2.27

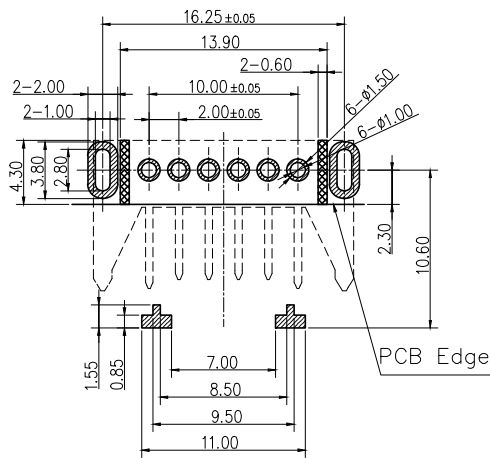

Stand Off(Product)
 Stand Off(CAP)

RECOMMENDED PCB LAYOUT (TOP VIEW)
 GENERAL TOLERANCES: ± 0.05 ($t=1.20$)

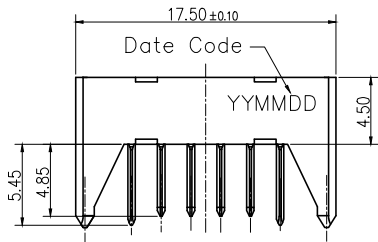
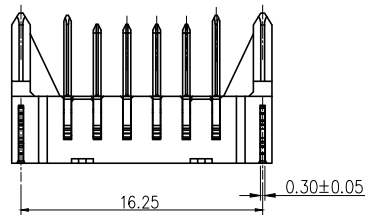
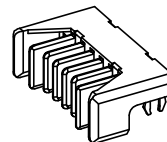
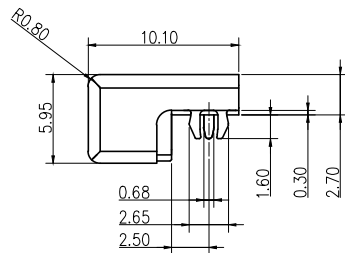
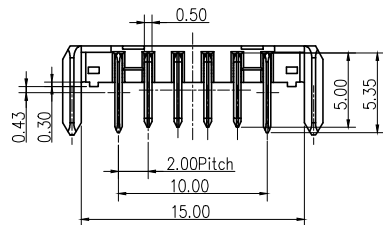

CONNECTOR WITH CAP

SCALE: 1: 2

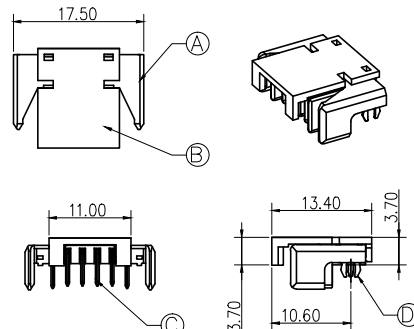

NOTES

- Electrical Spec:
 - Rated Current: 7A
 - Rated Voltage: 500V
- MECHANICAL CHARACTERISTIC:

Durability: 5,000 Cycles.
- PLATING:

Contact RESISTANCE: 30mΩ Max.
 Insulation Resistance: 1000MΩ Min.
 Dielectric Withstanding Voltage: 500V AC Min.
- TEMPERATURE:

Operating Temperature: -40°C ~+85°C
 Storage Temperature: -40°C ~+85°C
- PRINTED DATE CODE "YYMMDD" ON TOP OF CONNECTOR.
- HALOGEN PRODUCT IDENTIFICATION LABEL ON PACKAGING.
- FOR REFLOW SOLDERING LEAD-FREE PROCESS.

D	FORK	2	COPPER ALLOY	MATT-TIN 100u" ON SOLDER AREA
C	TERMINAL	6	COPPER ALLOY	CONTACT AREA : GOLD 10U" MATT-TIN 100u" ON SOLDER AREA
B	COVER	1	PA9T+45%GF	UL 94V-0 & BLACK
A	HOUSING	1	PA9T+45%GF	UL 94V-0 & BLACK
NO	DESCRIPTION	QTY	MATERIAL	PLATING & COLOR
UNLESS OTHERWISE SPECIFED TOLERANCES			Singatron Enterprise Co., Ltd. 信音企業股份有限公司	
DECIMALS:		TITLE: BATTERY MALE 6PIN DIP TYPE PITCH: 2.0		
ANGLES:		DWN: YUREN PART NO.2BA3Y15-006411F		
X	:±0.5	X	:±2°	
X.X	:±0.3	X.X	:±1°	
X.XX	:±0.2			
APVD	LIAO	SIZE: A3	SHEET: 1 OF 1	REV: B
CUSTOMER COPY				