

REV.	ECN NO.	OR DESCRIPTION	REVISED	DATE
A	PDR	RELEASE	KIKI	2007.12.10

SPECIFICATIONS:

- GREEN PRODUCT IDENTIFICATION LABEL IN PACKING: **G.P. PASS**
- "TO CONFORM TO THE "SE-01-001" & "ROHS DIRECTIVE"
- SOLDER HEAT RESISTANCE : 260°C 10 SECS.
- SEE "2MJ1510 SERIES" SPECIFICATION
- PACKAGE : SEE "2MJ1510 SERIES" PACKAGE
- PLUG : 5-1 MATED PLUG FOR S-VIDEO
5-2 PLUG FOR OPTICAL CONNECTOR PER EIAJ RC-5720B

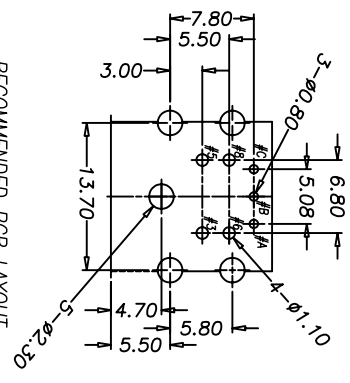
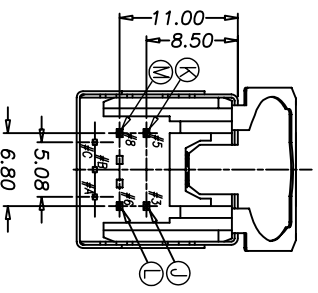
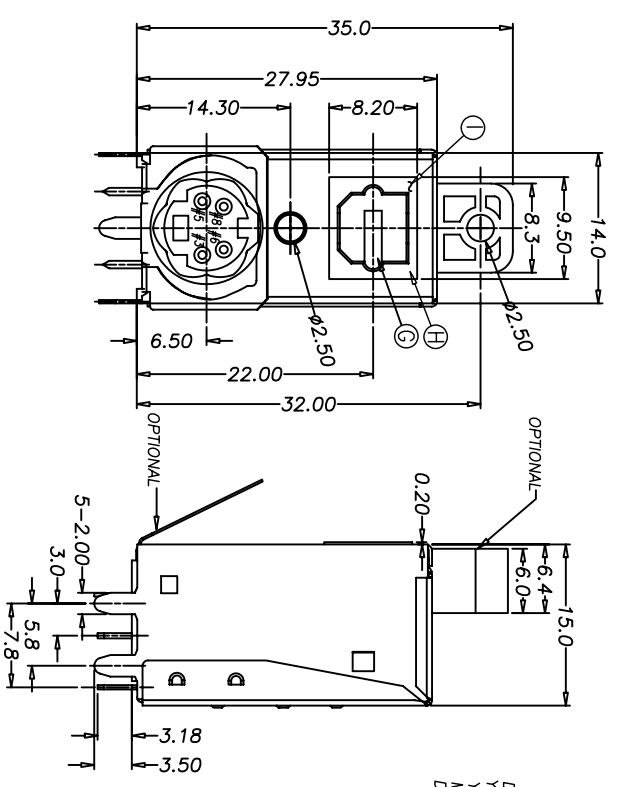
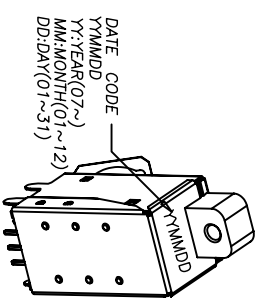

NOTE : TOLERANCE FOR PCB LAYOUT IS ± 0.05

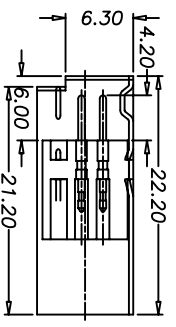
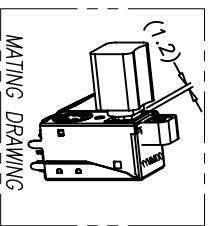
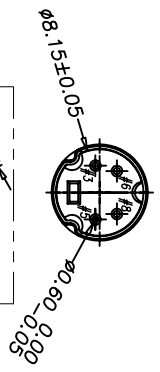
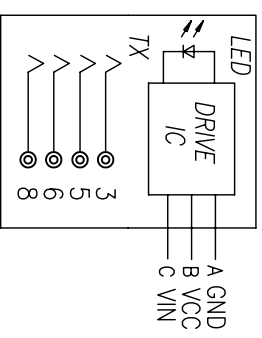
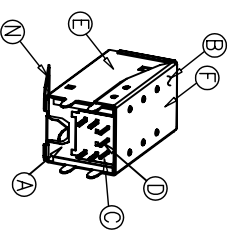
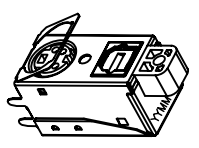

PART NO.
2MJ1510-000111

PACKAGE
1: TRAY
HOUSING COLOR
1: BLACK
CONTACT PLATING
1: Au/Sn

NO	DESCRIPTION	QTY	MATERIAL	PLATING & COLOR
N	GND CONTACT	1	SUS 301	BLACK COLOR
M	CONTACT#8	1	PBS C5191-RH	Au/Sn PLATING
L	CONTACT#6	1	PBS C5191-RH	Au/Sn PLATING
K	CONTACT#5	1	PBS C5191-RH	Au/Sn PLATING
J	CONTACT#3	1	PBS C5191-RH	Au/Sn PLATING
I	COIL SPRING	1	SUS 301	
H	FRAME	1	PA9T	BLACK COLOR
G	GATE	1	PA9T	LIME GREEN COLOR
F	BACK SHIELD	1	BRASS	NI PLATING
E	S-SHIELD	1	BRASS	Sn PLATING
D	DRIVE IC/TX	1	PA9T	BLACK COLOR
C	COVER	1	PA9T	BLACK COLOR
B	MINOR HOUSING	1	PA9T	BLACK COLOR
A	HOUSING	1	PA9T	BLACK COLOR

UNLESS OTHERWISE SPECIFIED TOLERANCES:
DECIMALS: ANGLES:
X : ±0.5 X : ±2°
X.X : ±0.3 X.X : ±1°
X.XX : ±0.2

Singapore Enterprise Co., Ltd.
信音企業股份有限公司

TITLE: STACKED JACK/FULLY SHIELDED
MD 4P / OPTO JACK

DWN KIKI 2008.11.18 PART NO. 2MJ1510-000111

CHKD JHNSN 2008.11.18 SCALE: 1/1 UNIT: mm

APVD PANTON 2008.11.18 SIZE: A3 SHEET: 10F1 REV: A

CUSTOMER COPY