

1 2 3 4 5 6 7 8 9 10 11 12 13

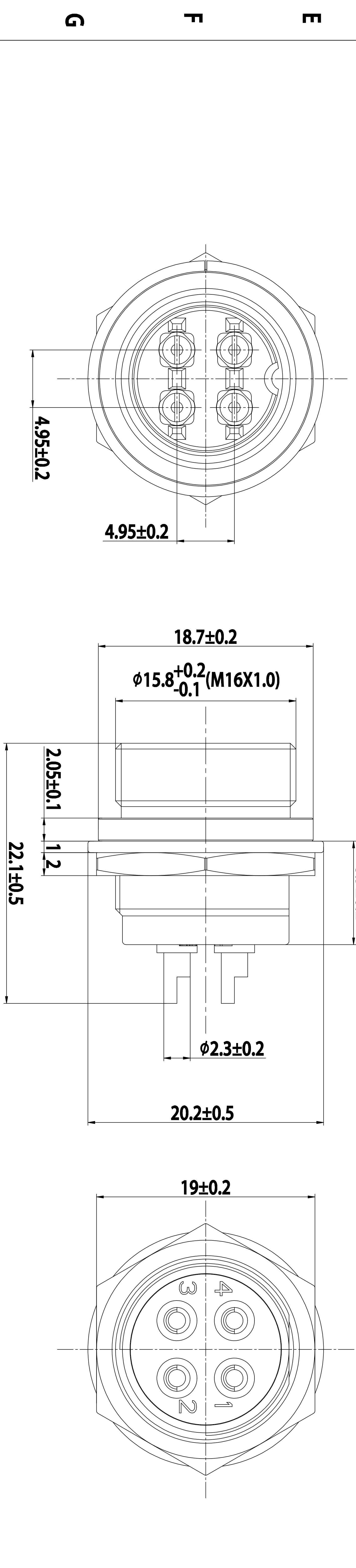
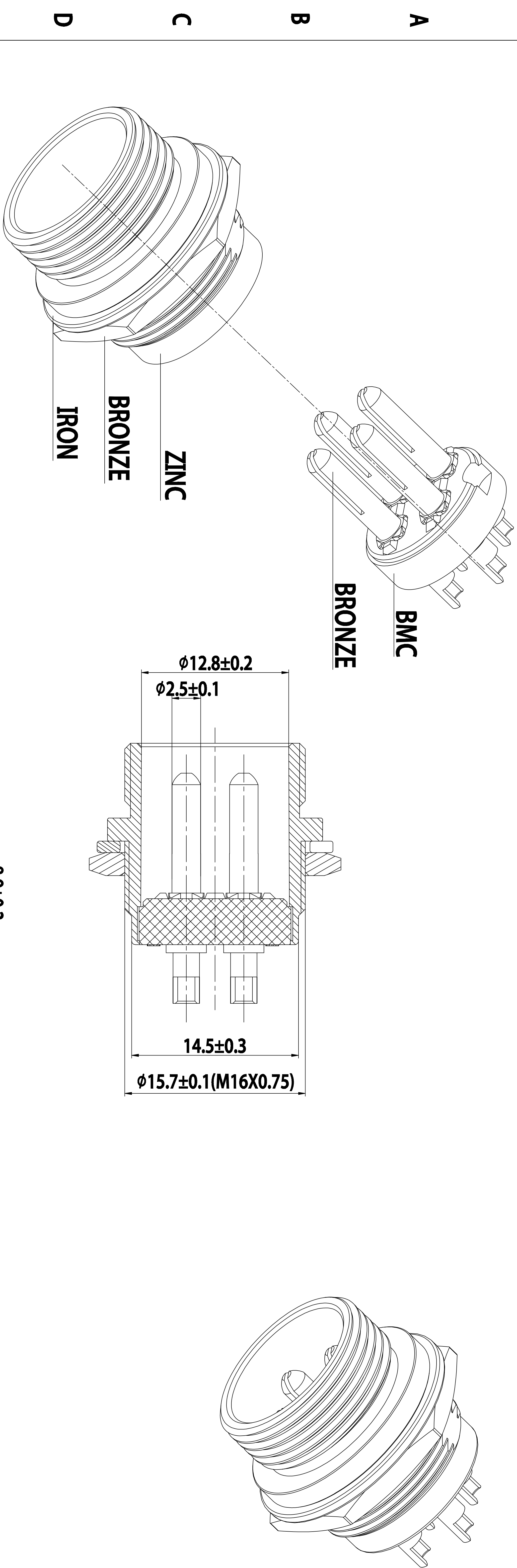

料號 PART NO.	2XR-91M701-4P	設計 DESIGN	Jacky Lin	製圖 DRAWER	Andy Lin	核對 SCALE	Jacky Lin	SINGATRON (U.S.A.)
品名 TITLE	CORD PLUG	材料 MATERIAL		比例 RATIO	1:2	日期 DATE	2010/08/27	