

# Side Entry Low Profile P.C.Board Jack

3019 Series

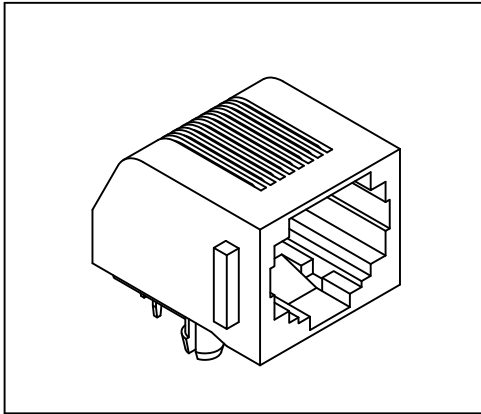

## Material and Finish:

- \* Housing: PBT Polyester UL94V-0 mixed Glass Fiber  
Standard Color: Black
- \* Contact: 0.35mm Thickness Phosphor Bronze  
Plated with Hard Gold and  
Gold Flash in Solder Area
- \* Cavity confirms to FCC rules and regulations part 68,  
subpart F.
- \* RoHS compliant.

## P.C.B. Hole Layout

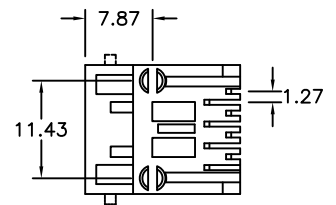
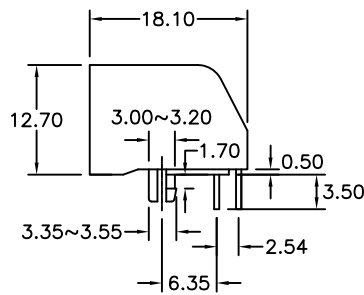
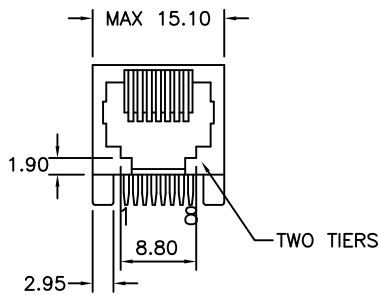
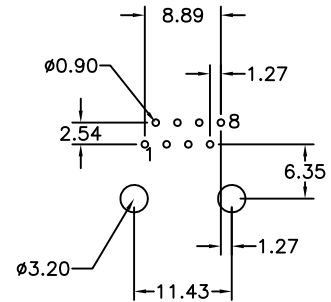
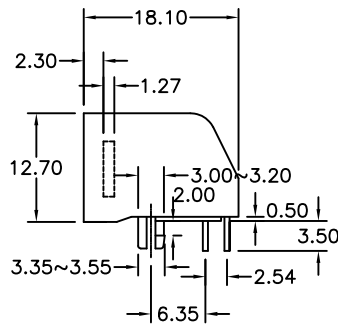
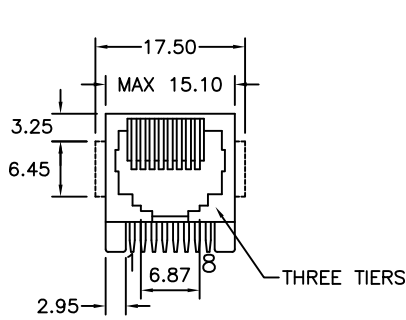

## Ordering Information

Series No.	Panel Stop	No. of Position	No. of Contact	Keyed	Contact Plating
3019	F	8	8	2	1
	with Panel Stop <input type="checkbox"/> F	<input type="checkbox"/> 6	<input type="checkbox"/> 2	w/o key <input type="checkbox"/> 2	6 $\mu$ " <input type="checkbox"/> 1
	w/o Panel Stop <input type="checkbox"/> L	<input type="checkbox"/> 8	<input type="checkbox"/> 4		15 $\mu$ " <input type="checkbox"/> 2
			<input type="checkbox"/> 6		30 $\mu$ " <input type="checkbox"/> 3
			<input type="checkbox"/> 8		50 $\mu$ " <input type="checkbox"/> 4
					F $\mu$ " <input type="checkbox"/> 0